

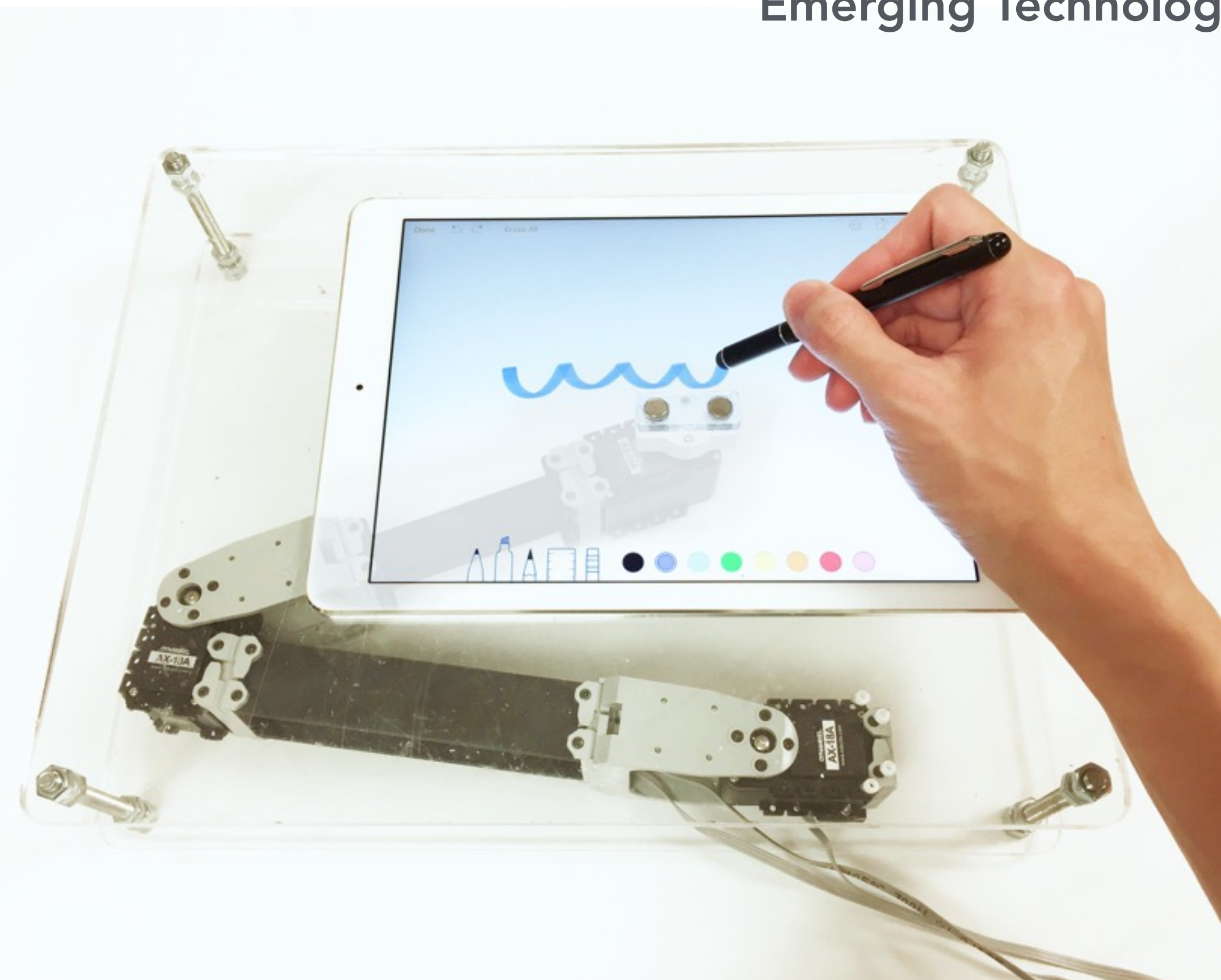

SIGGRAPH
ASIA 2016
MACAO



Stylus Assistant: Designing Dynamic Constraints for Facilitating Stylus Inputs on Portable Displays

Long-Fei Lin, Shan-Yuan Teng, Rong-Hao Liang, Bing-Yu Chen

National Taiwan University



National
Taiwan
University

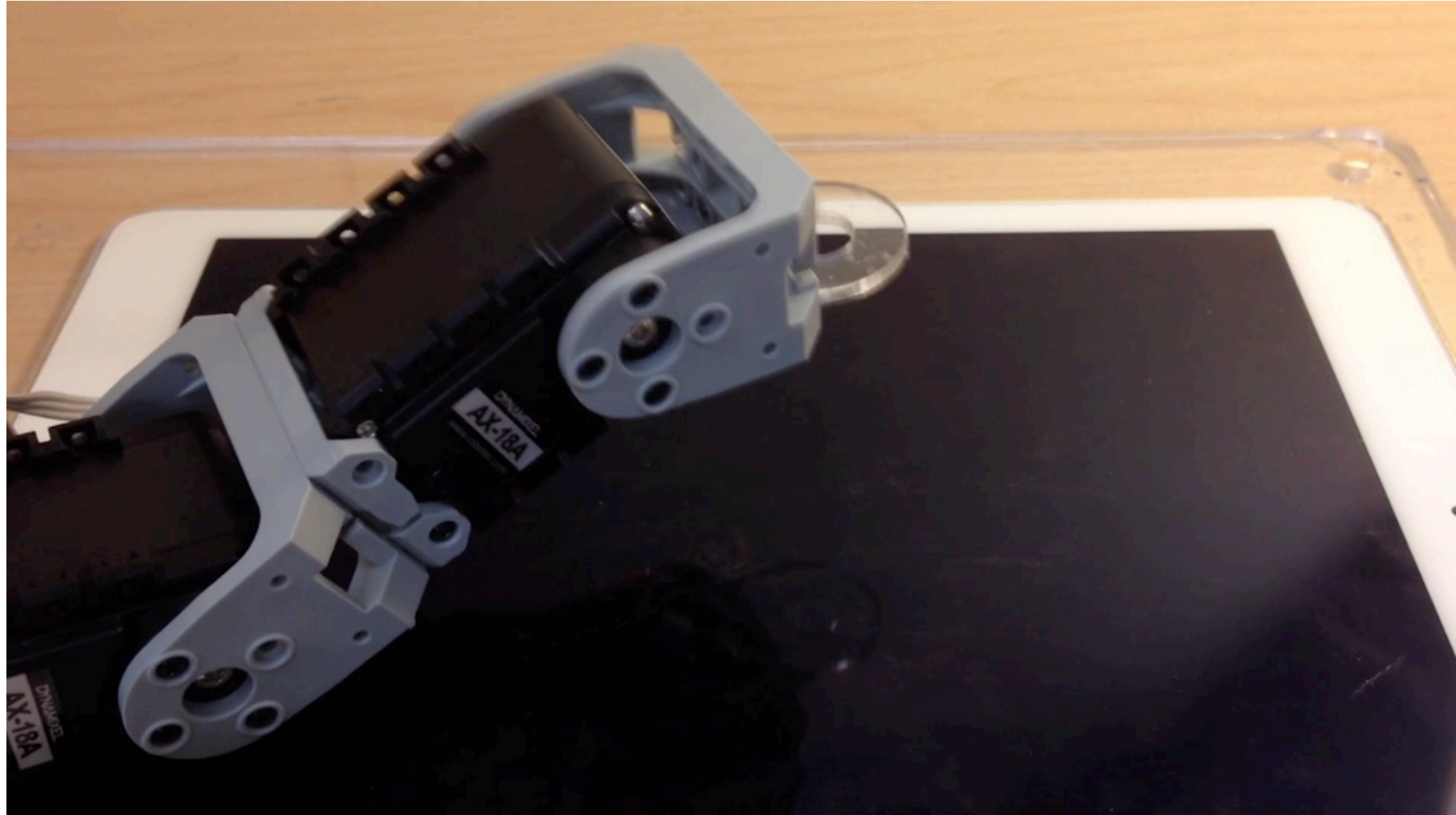

DynaFrame: Around-Display Constraint

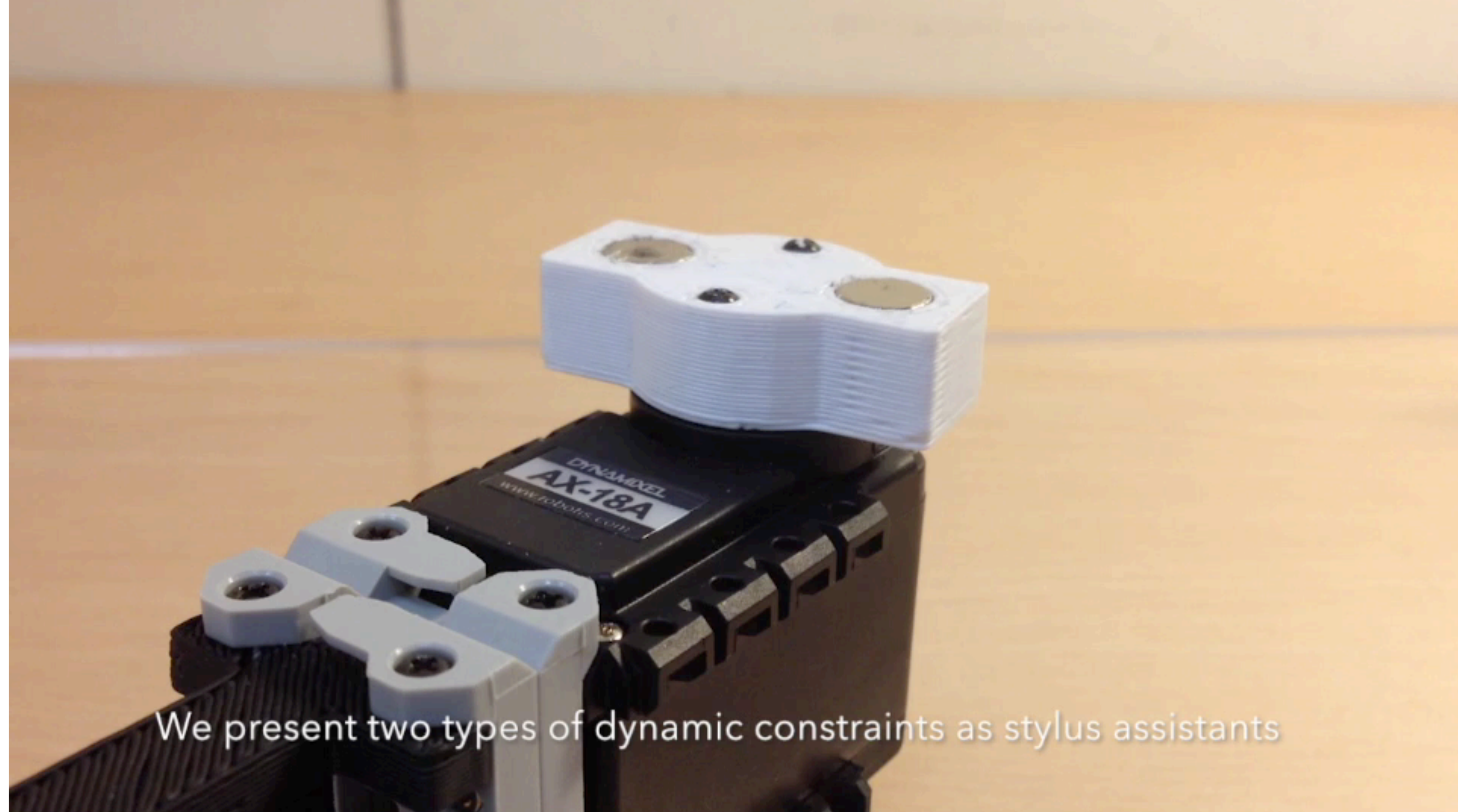

We present two types of dynamic constraints as stylus assistants

DynaBase: Back-of-Display Constraint

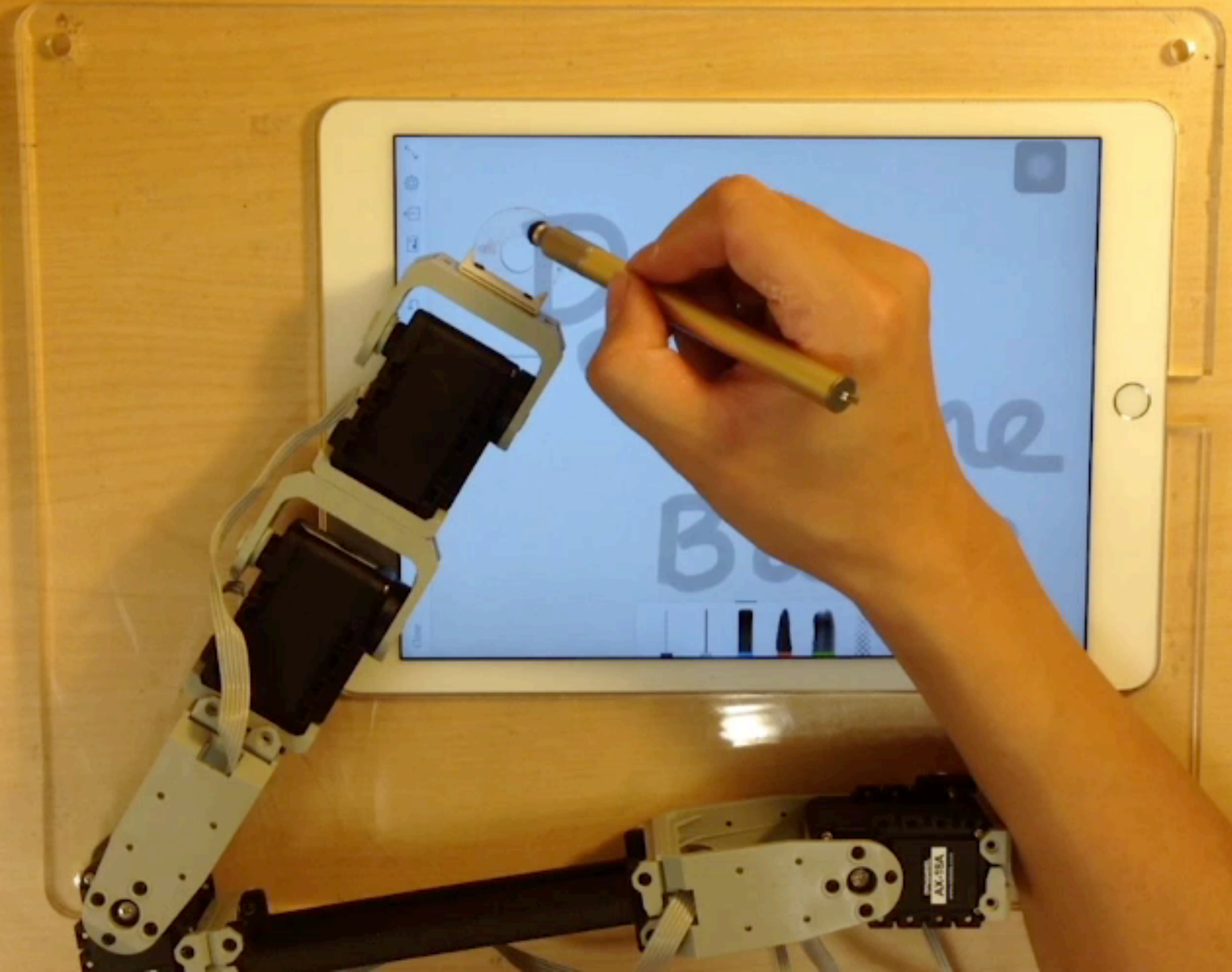

Introduction



Portable displays
+
stylus input



only visual guidance
no force feedback

Related Work



[Nakagaki et al., UIST'15]

LineFORM: Actuated Curve Interfaces for Display, Interaction, and Constraint



[Yamaoka and Kakehi., UIST'13]

dePENd: Augmented Sketching System Using Ferromagnetism of a Ballpoint Pen



Not grounded to the display.

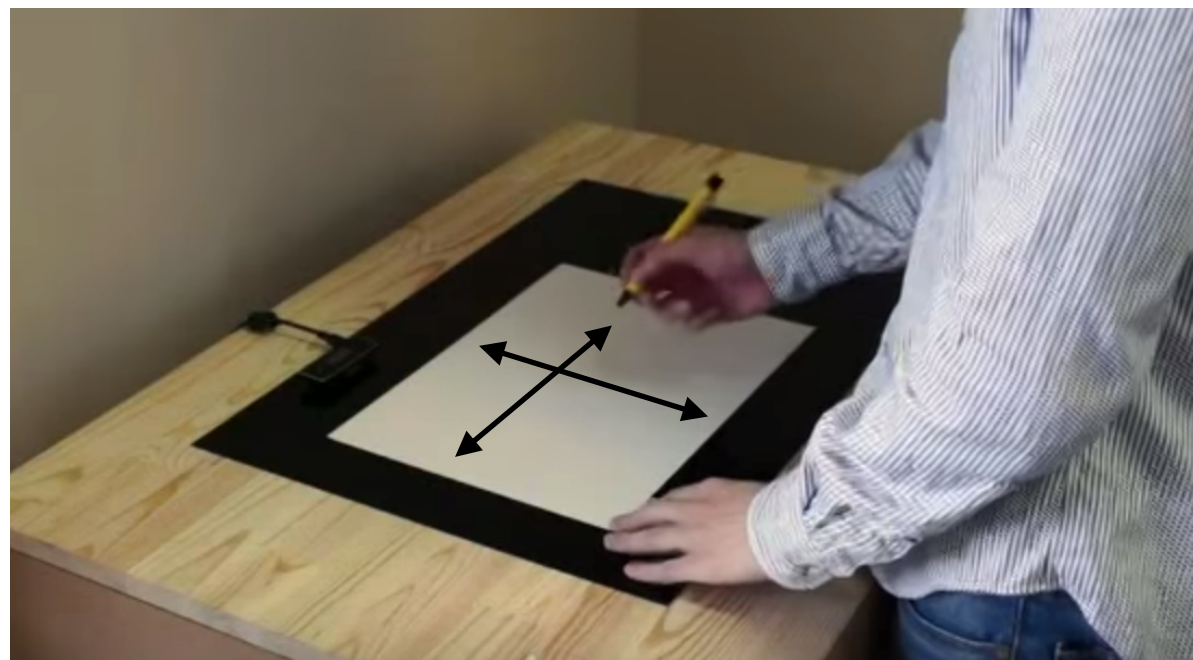

Not suitable for portable displays.

**provide enough force feedback
for guidance on portable displays
in a reasonable form**

Design

1) As small occlusion as possible.

nearby the stylus tip / remaining area

2) Effectiveness.

precision / reaction time

3) Expressiveness.

position / speed / pressure

Guidance mechanism *above* the display



Guidance mechanism *under* the display

**Around-
display**

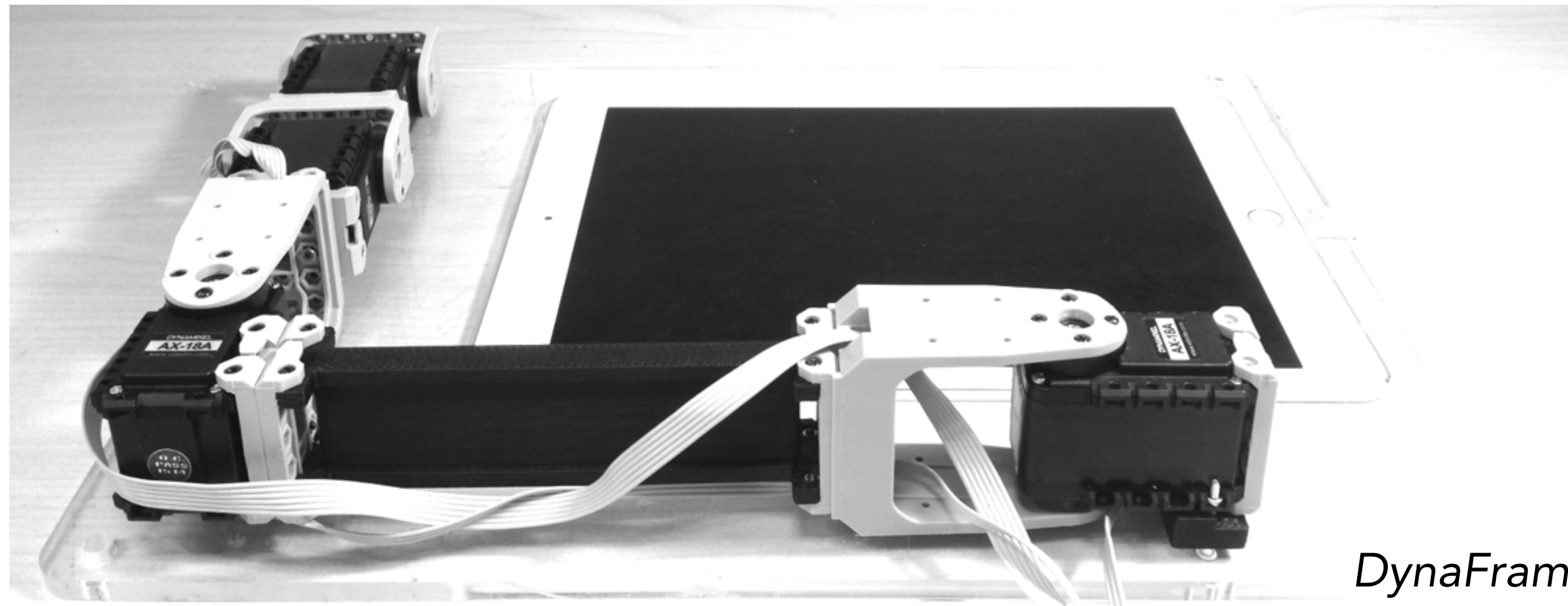
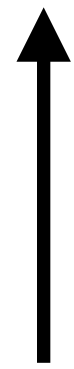

DynaFrame





**Back-of-
display**



DynaBase

Dynamixel AX-18A

No-load Speed: 97rpm ,0.103 sec/60°

Size: 32 x 50 x 40mm

Stall Torque: 18.3 kg·cm

Resolution : $300^\circ/1024 = 0.29^\circ$



DynaFrame

Around-display constraint

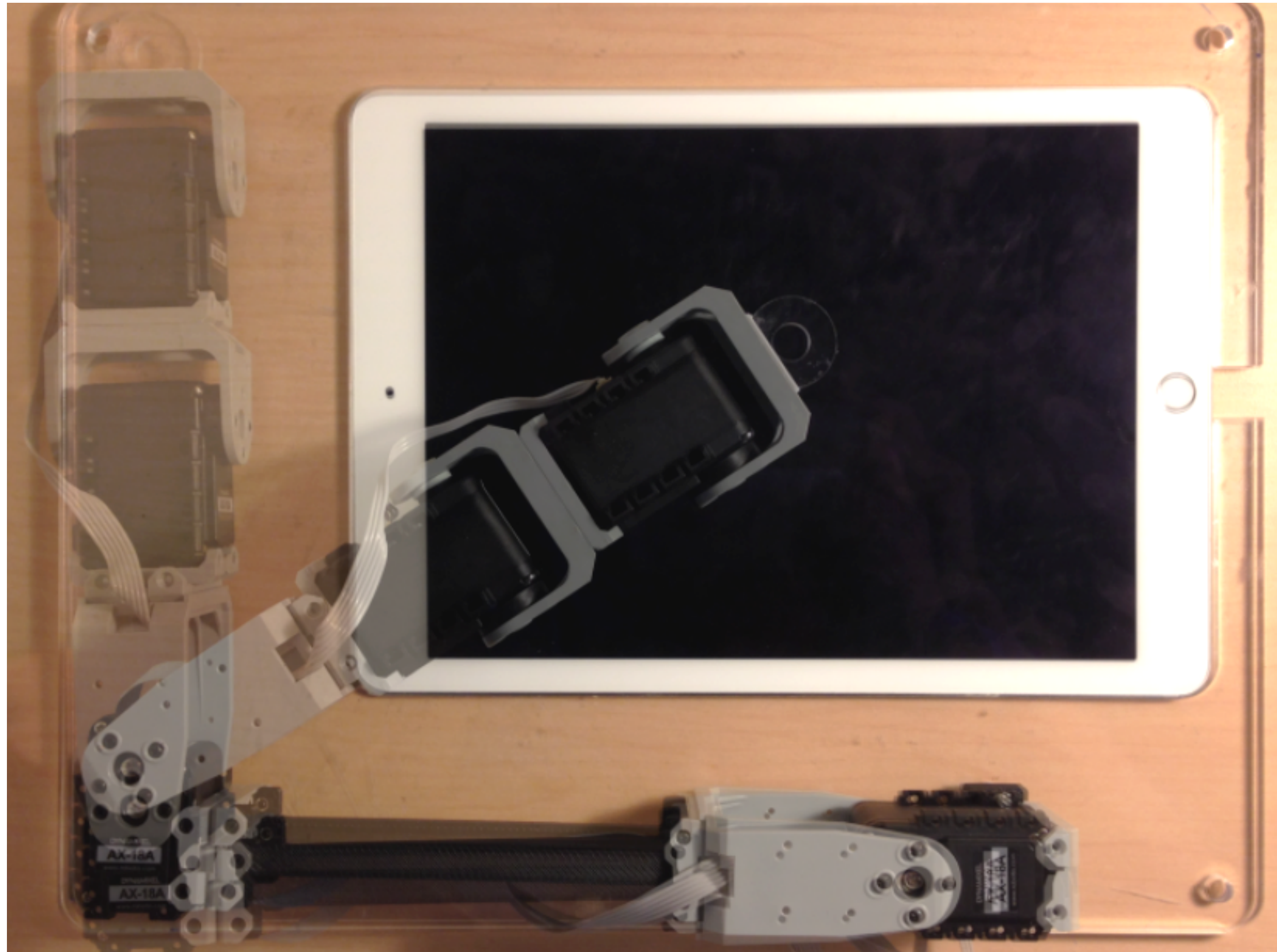

DynaFrame

Around-display constraint

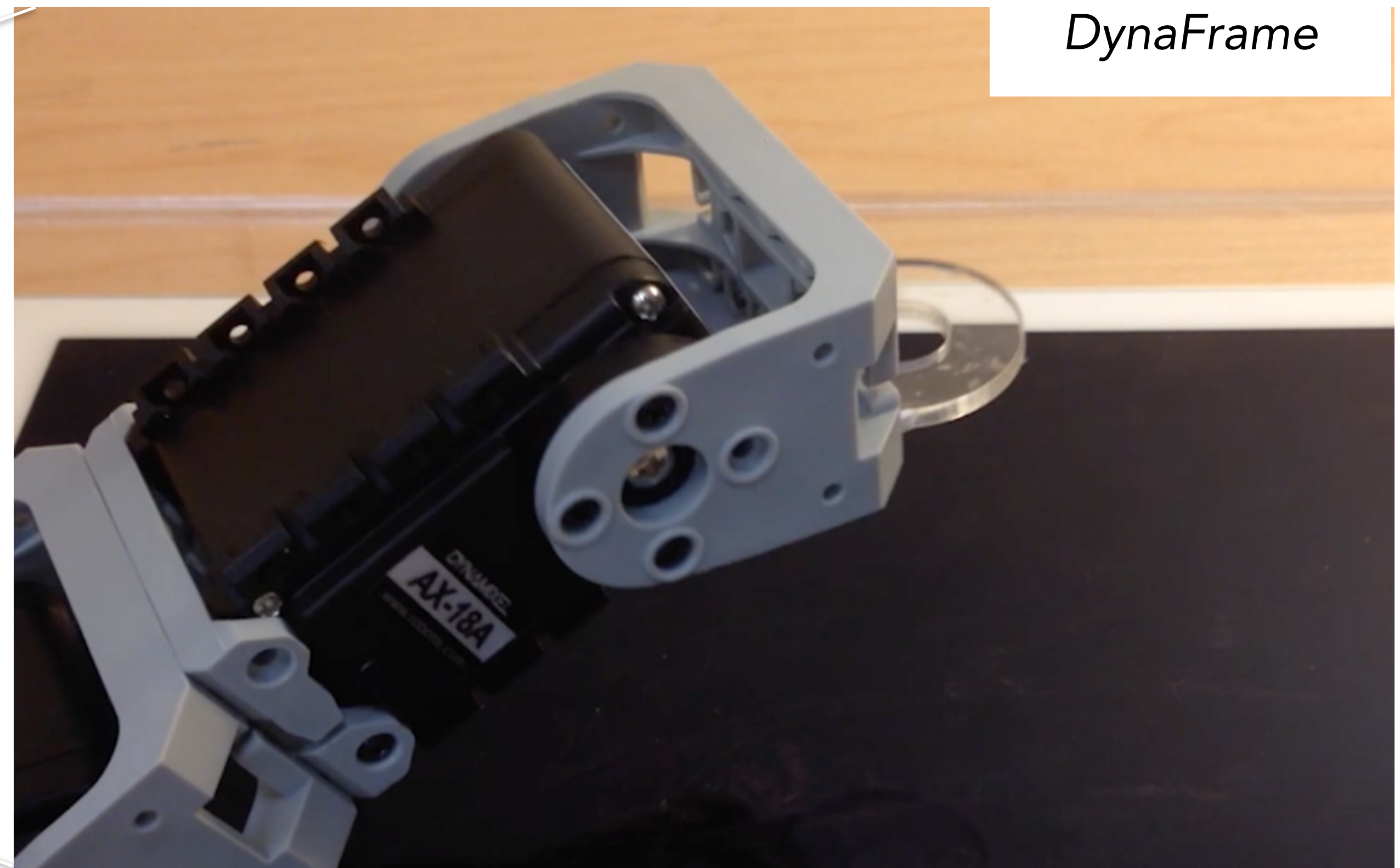
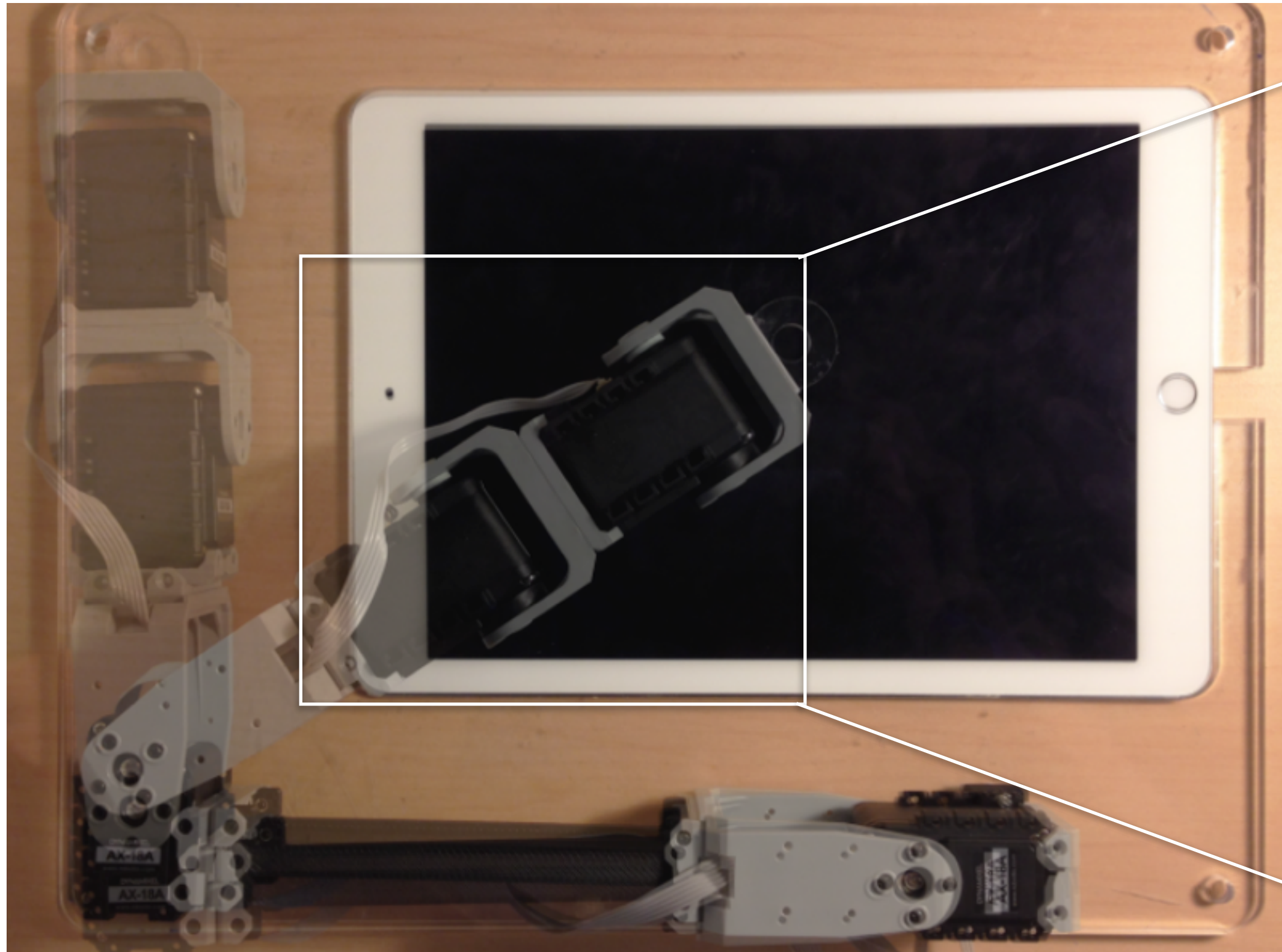

DynaFrame

2D Stylus Position: Inverse Kinematics (IK)

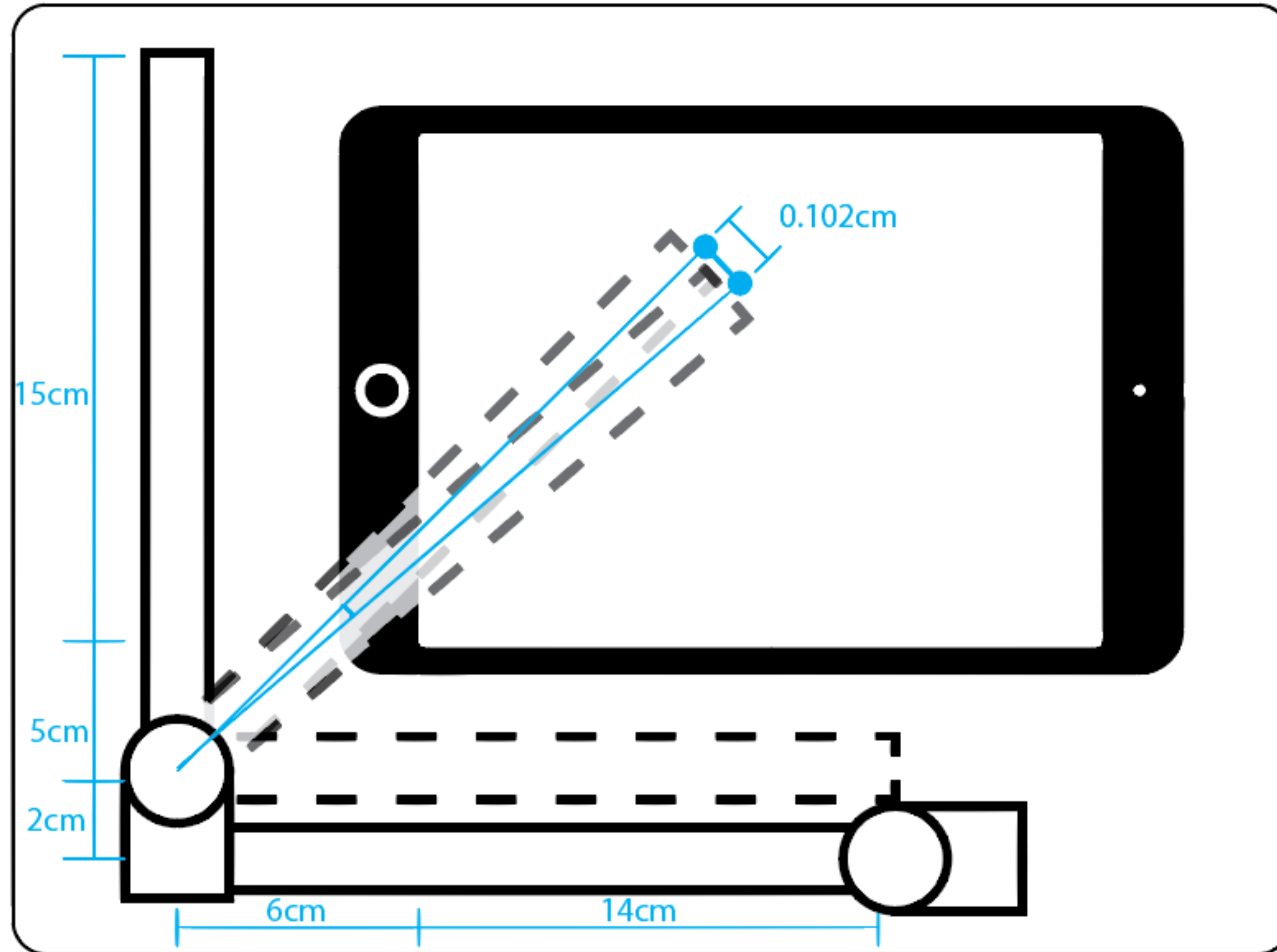

2D Stylus Position: Inverse Kinematics (IK)



Toward 3D:

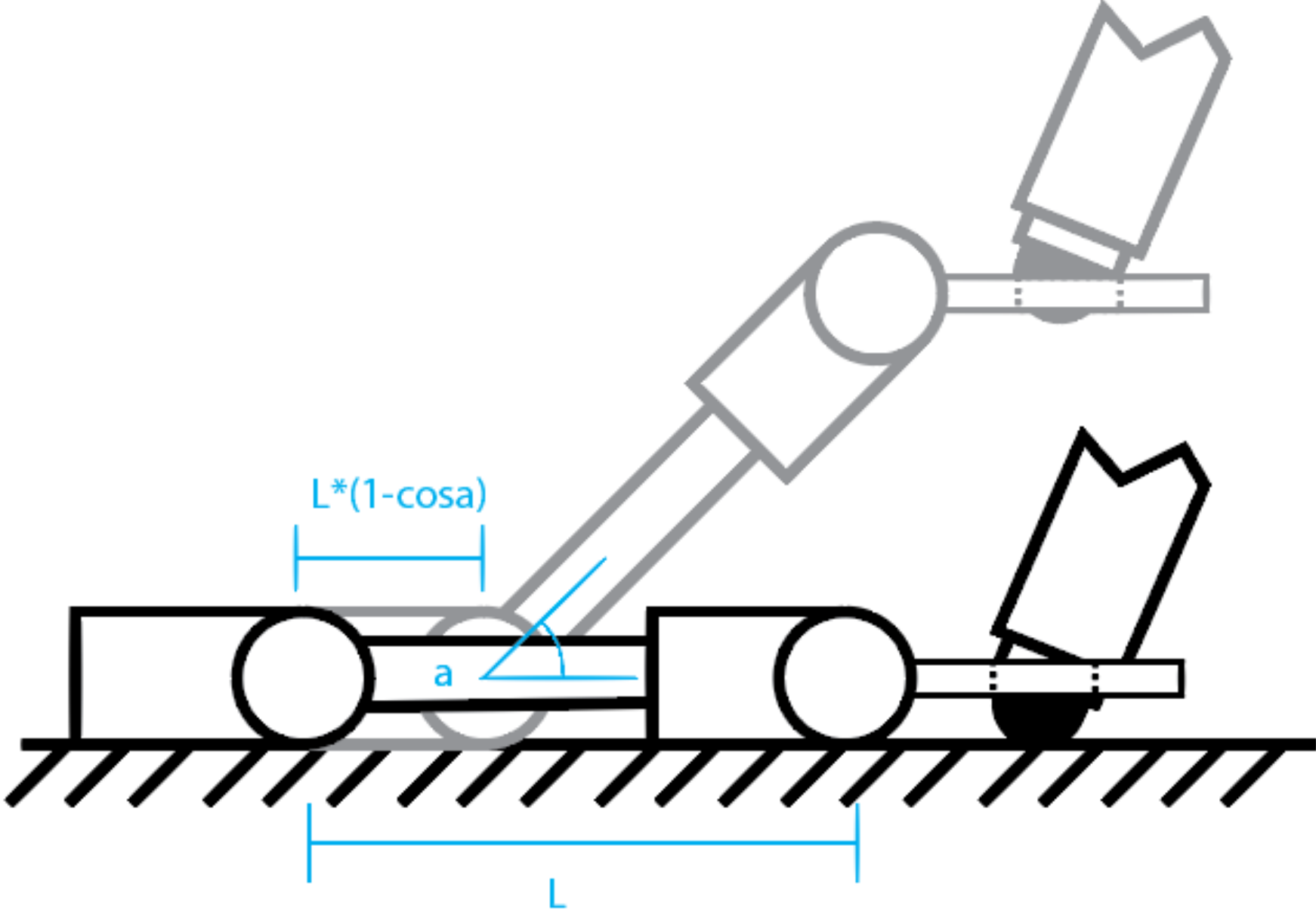
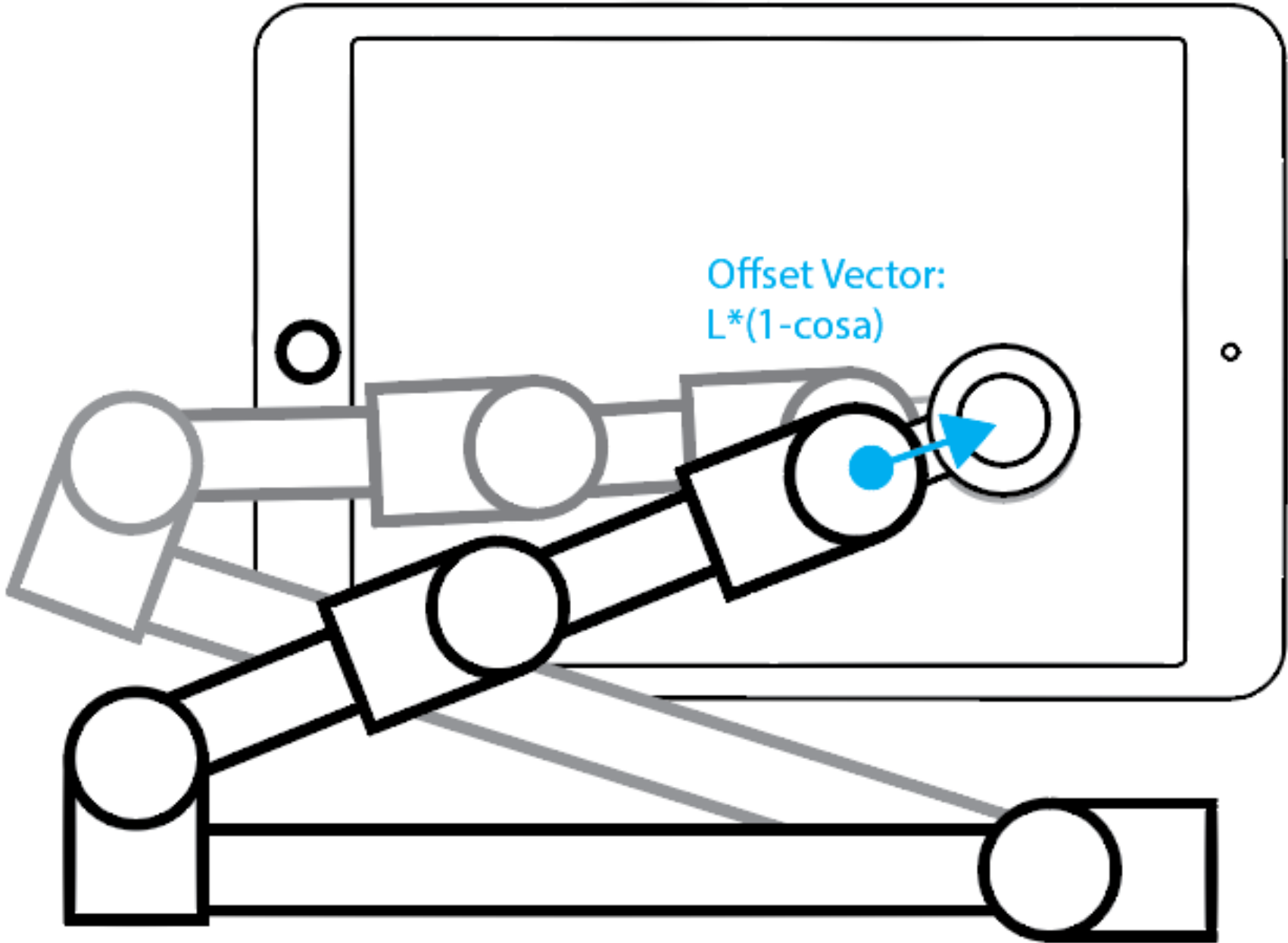

Toward 3D:

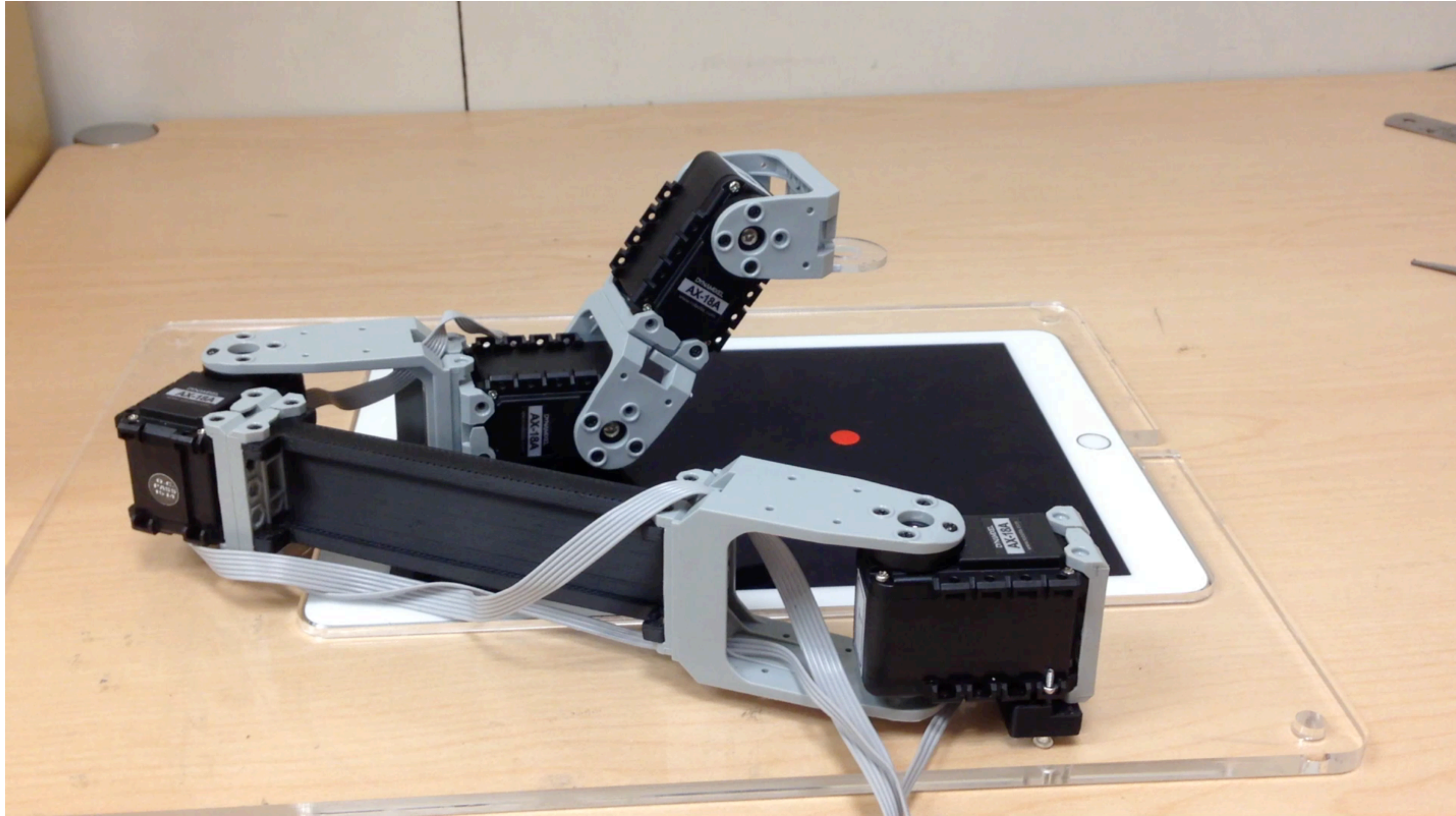

Interaction Procedure guidance

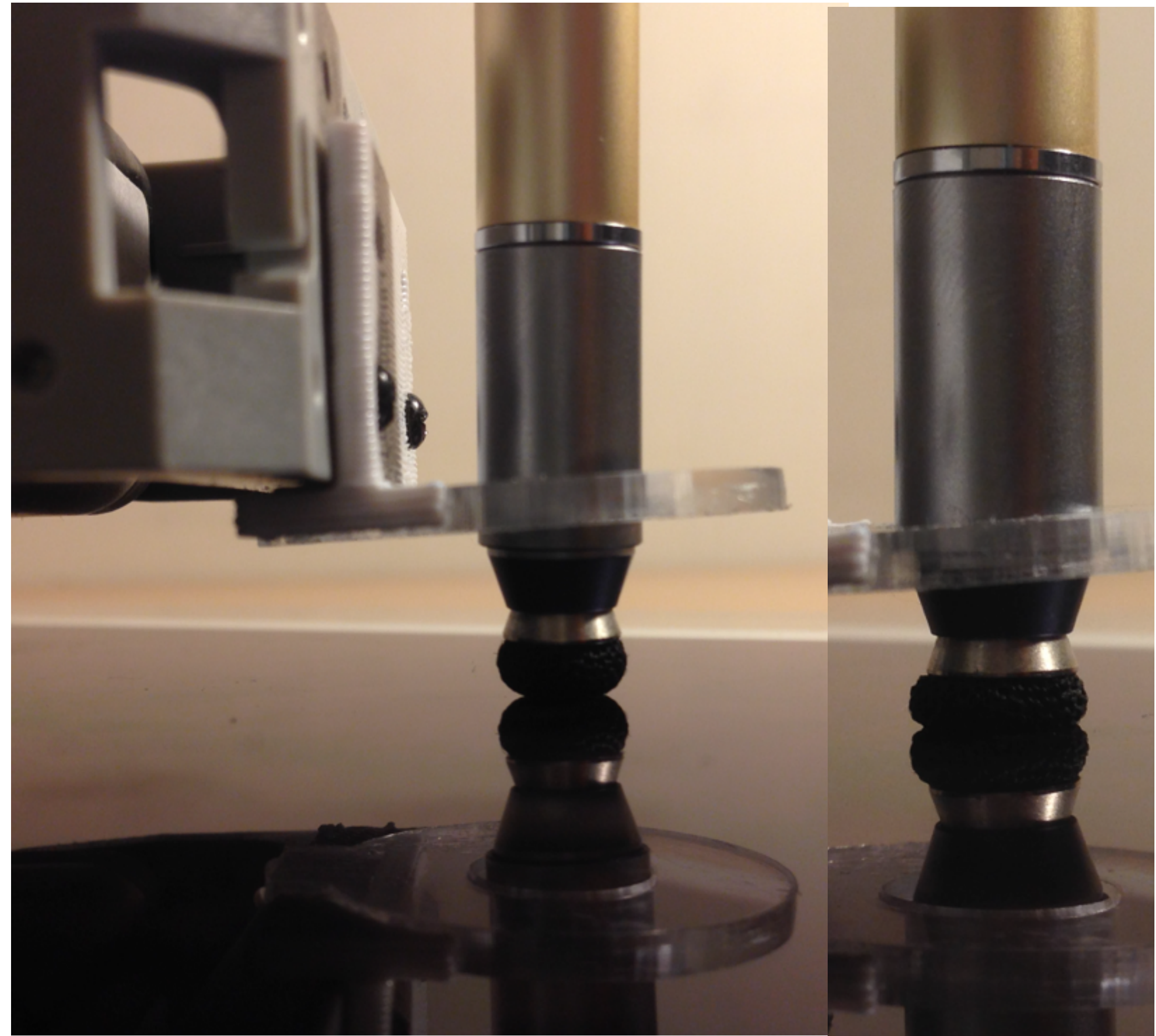
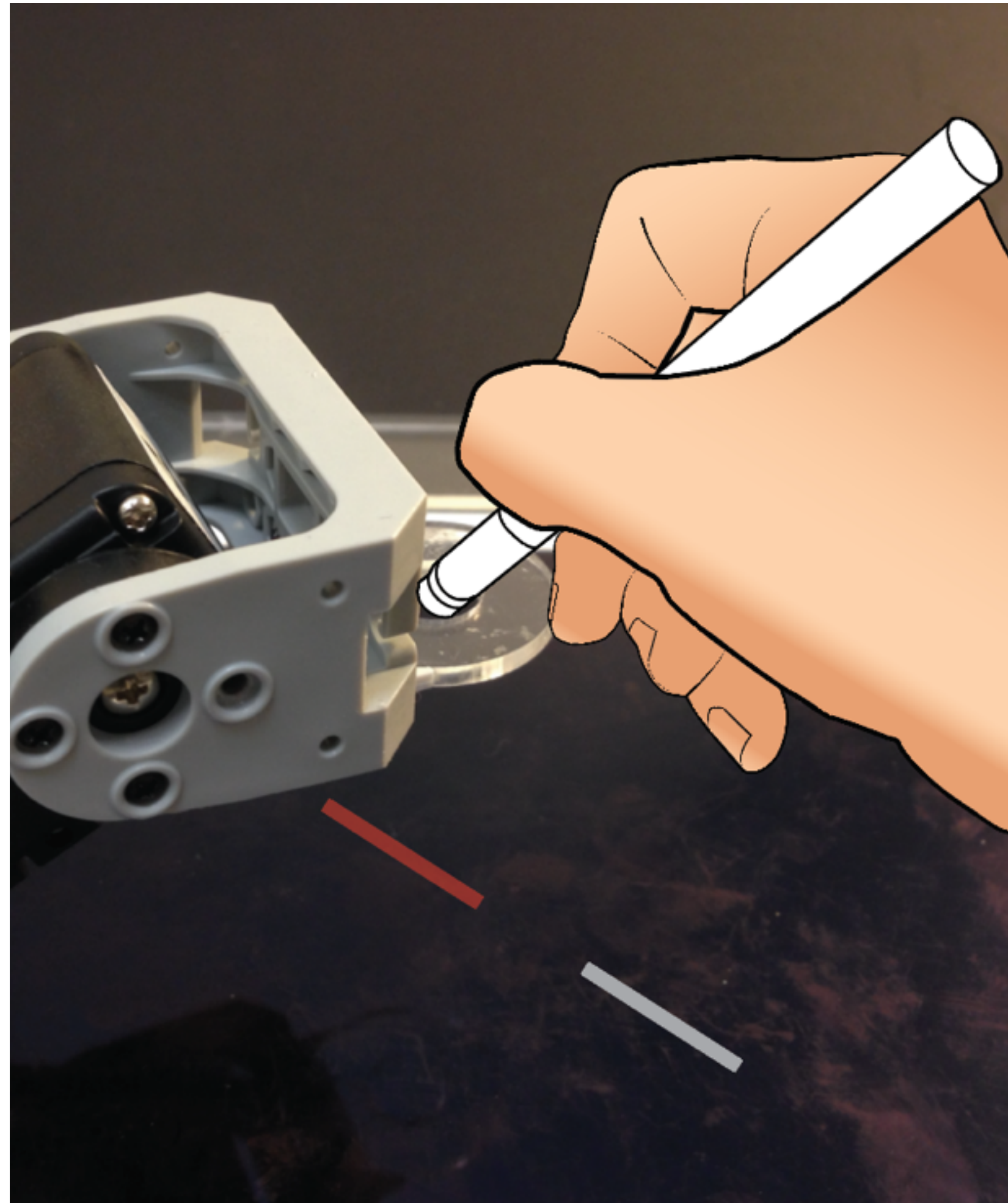

Application Writing

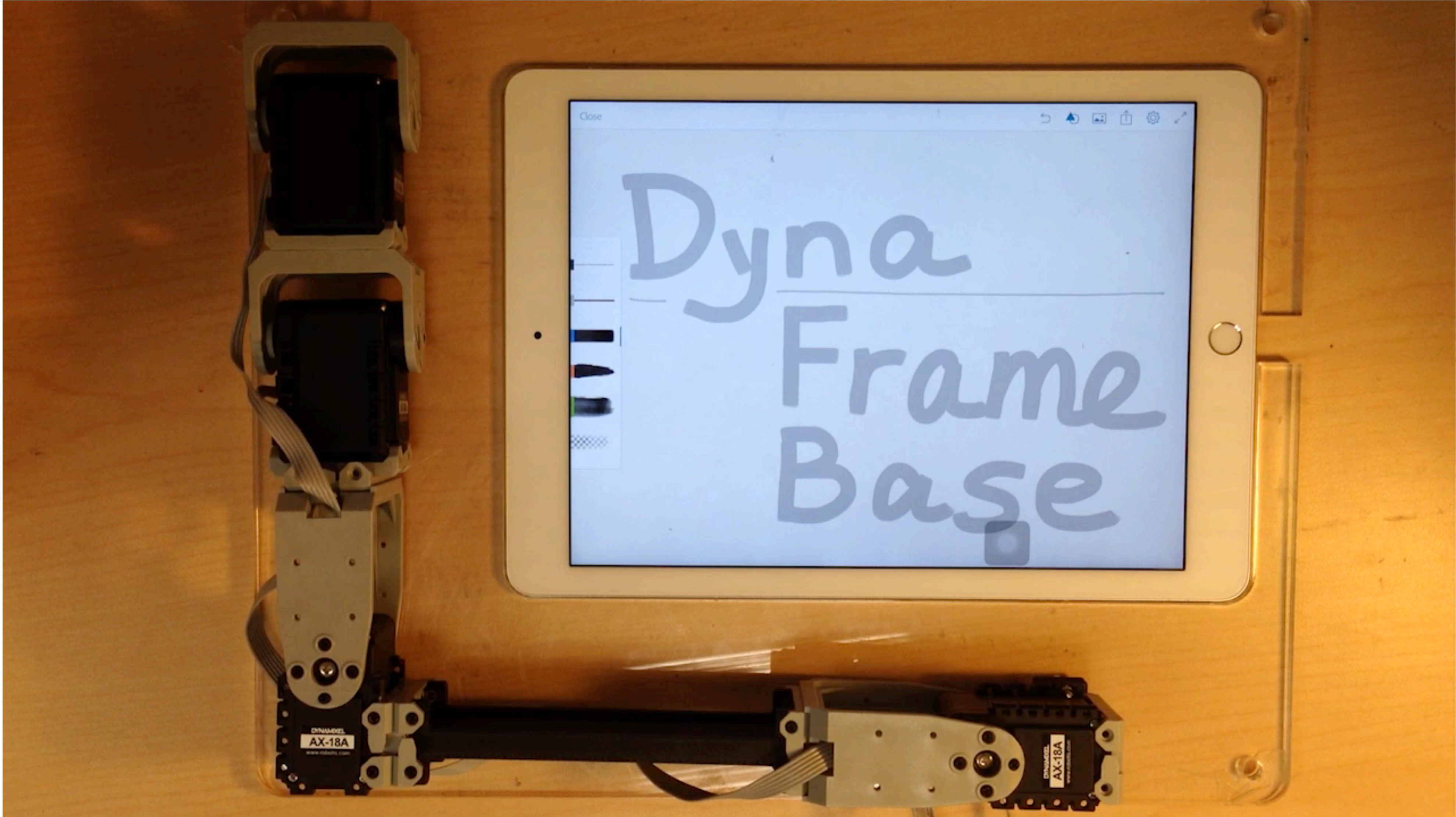

Application Playing

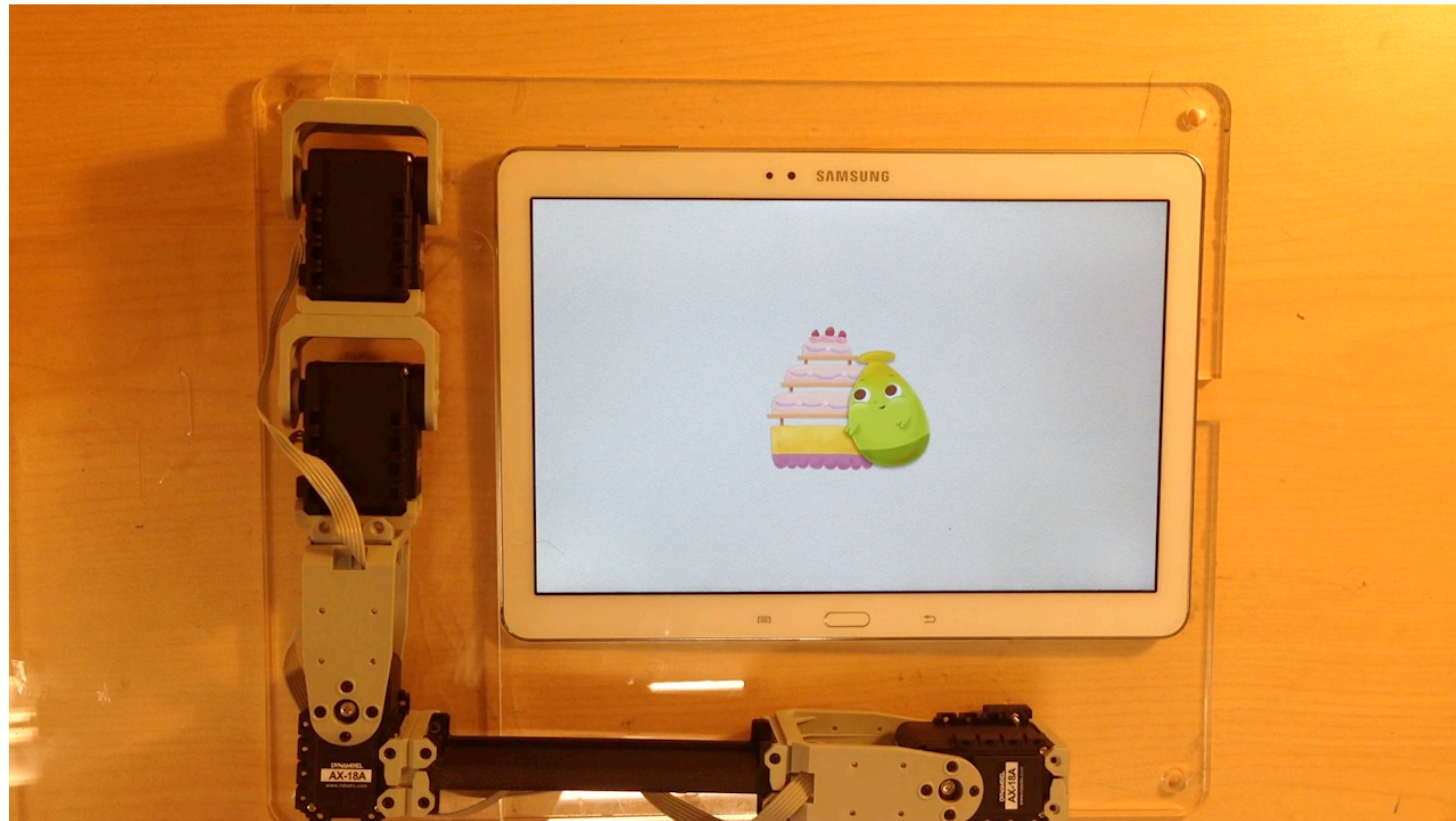

DynaFrame

Around-display constraint

3D guidance
with procedure

Good visibility

Occlusion



DynaBase

Back-of-display constraint

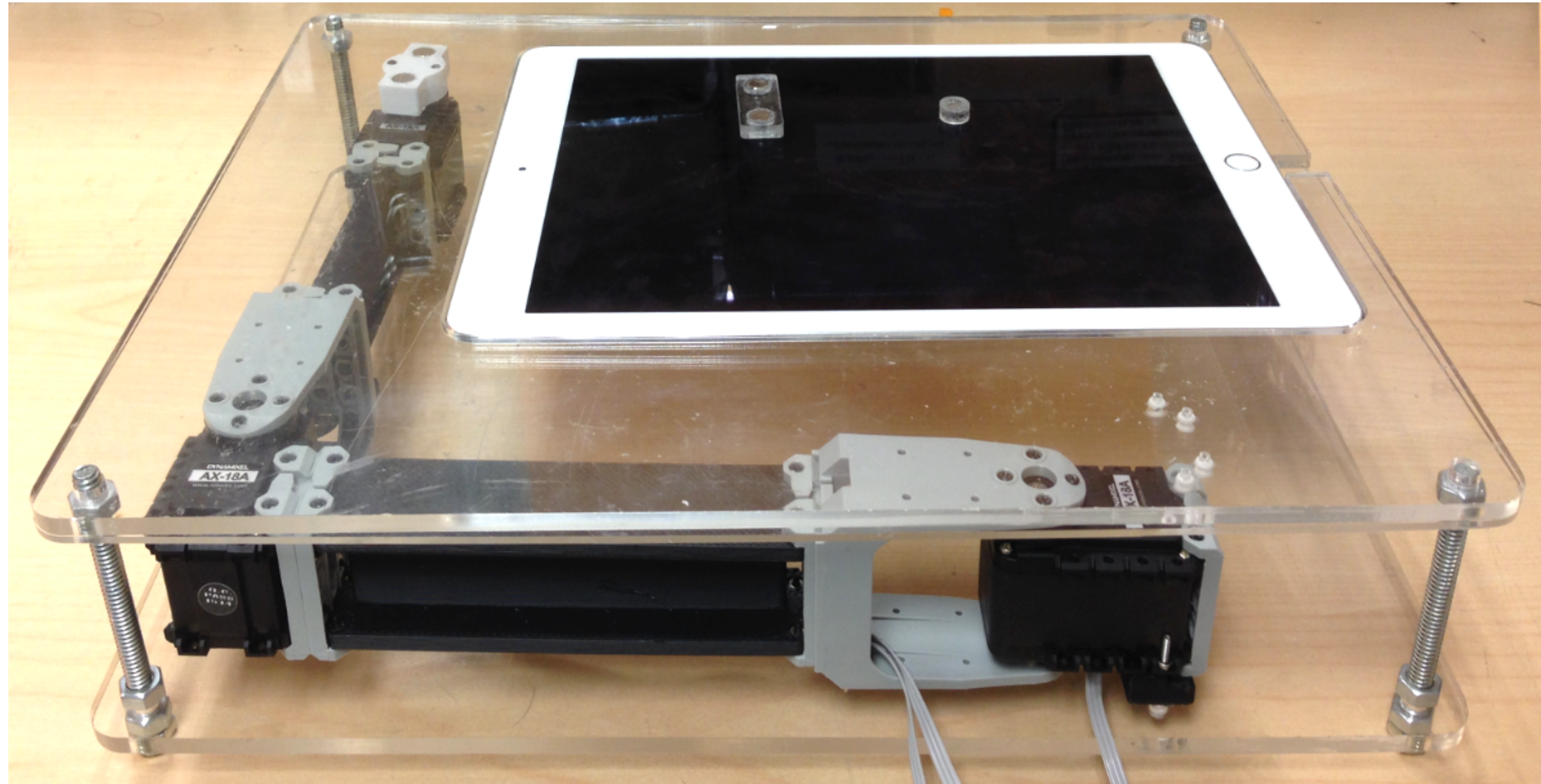

DynaBase

Back-of-display constraint

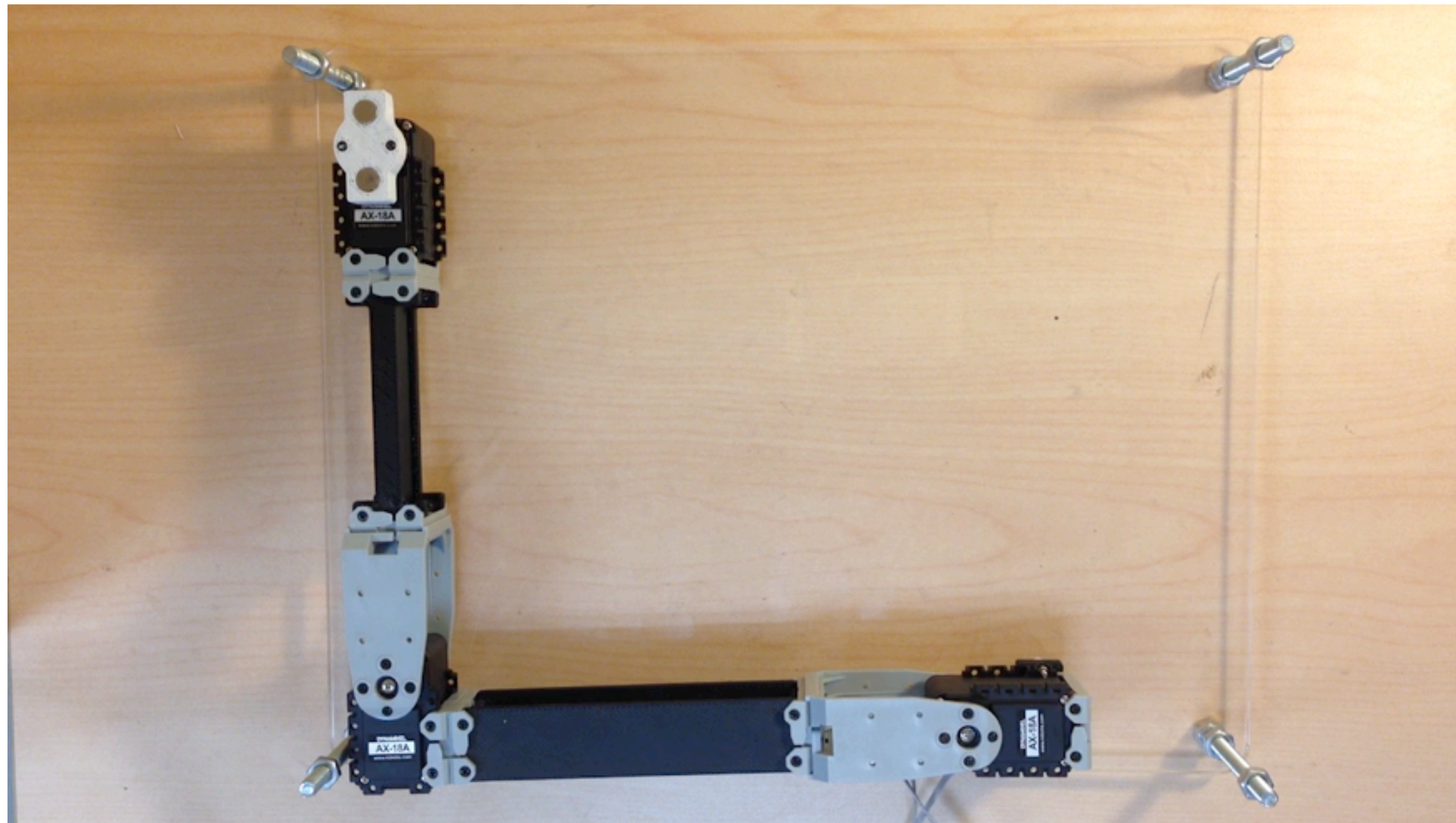

DynaBase

Back-of-display constraint

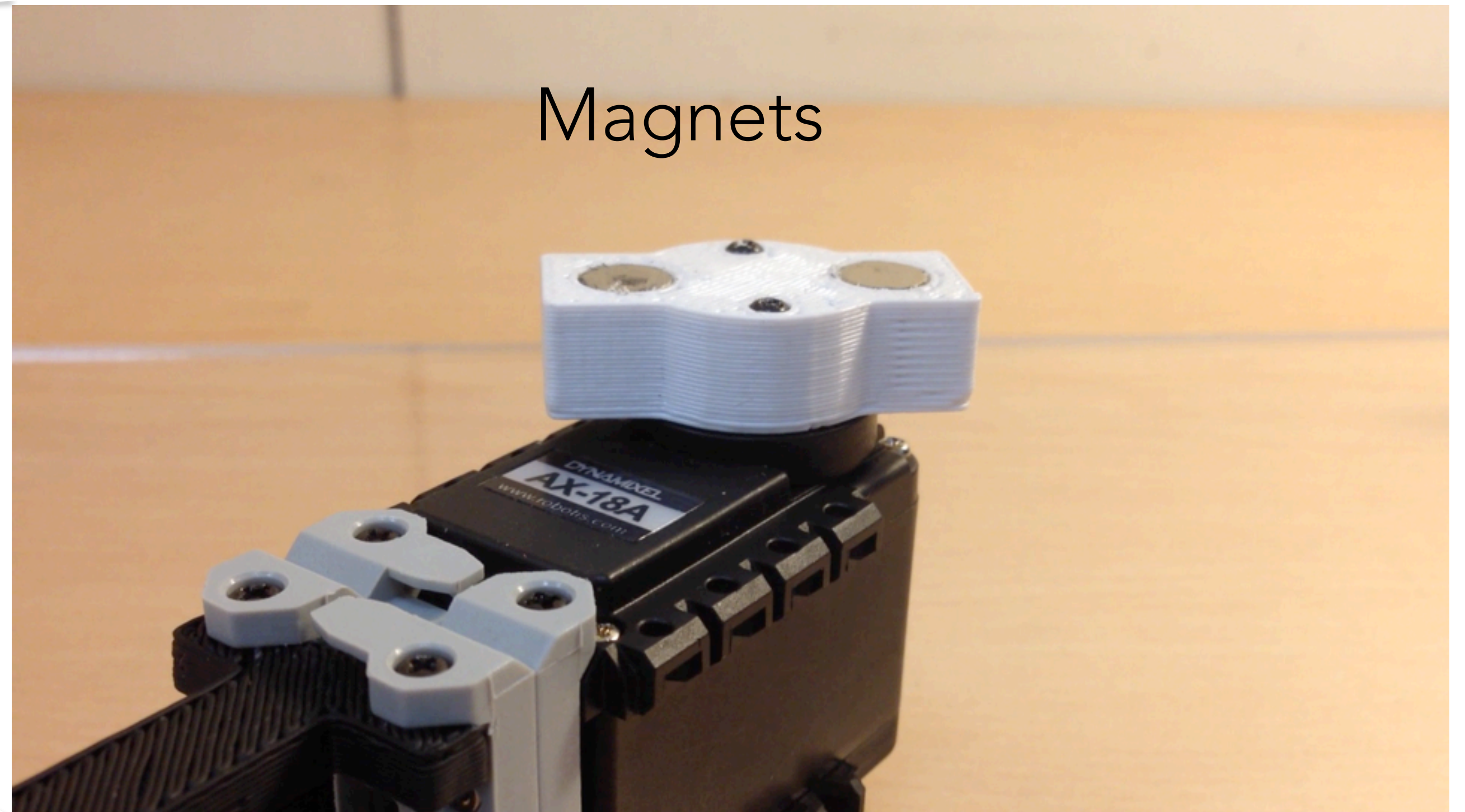
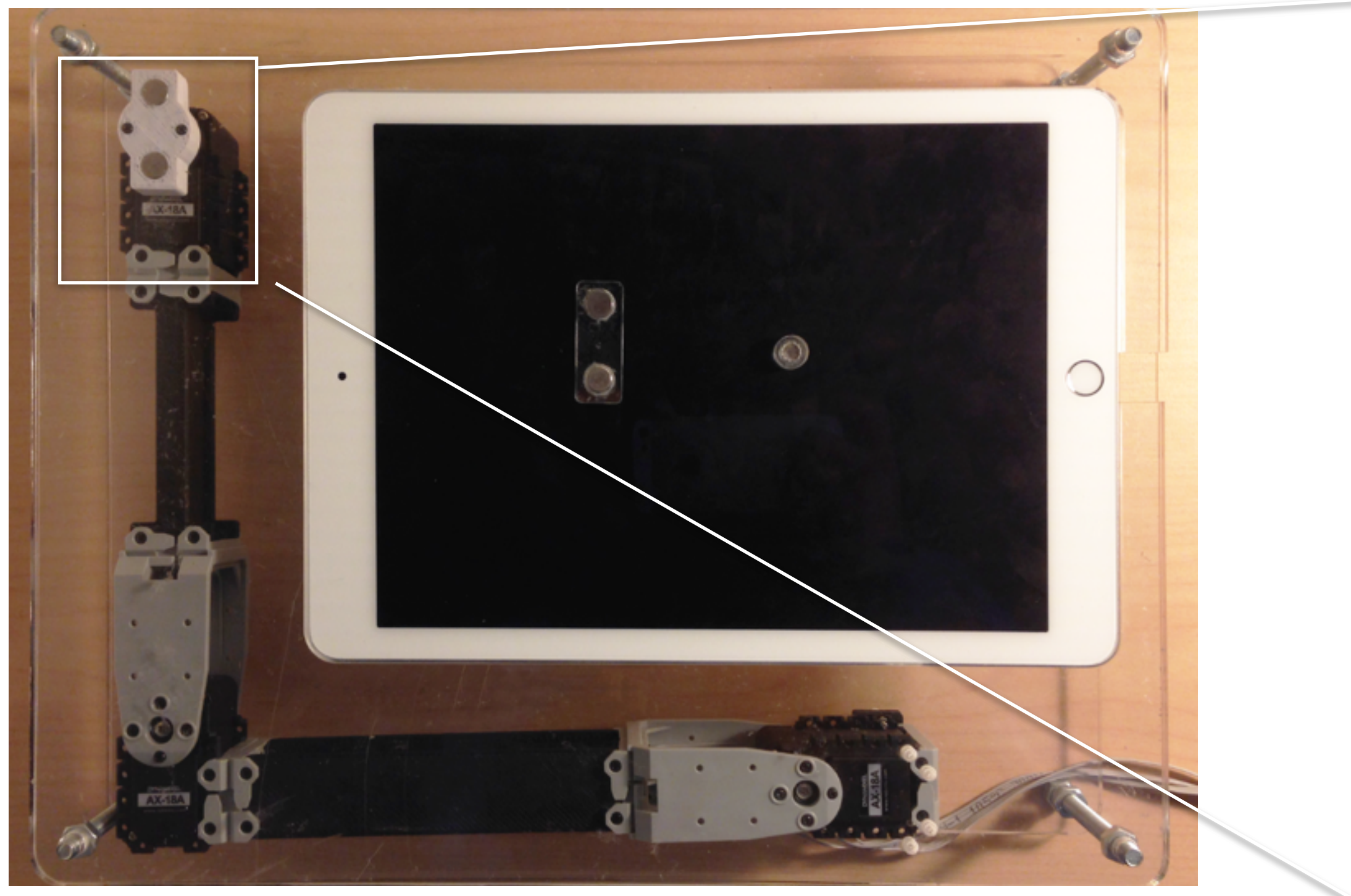

Interaction



Hard constraint

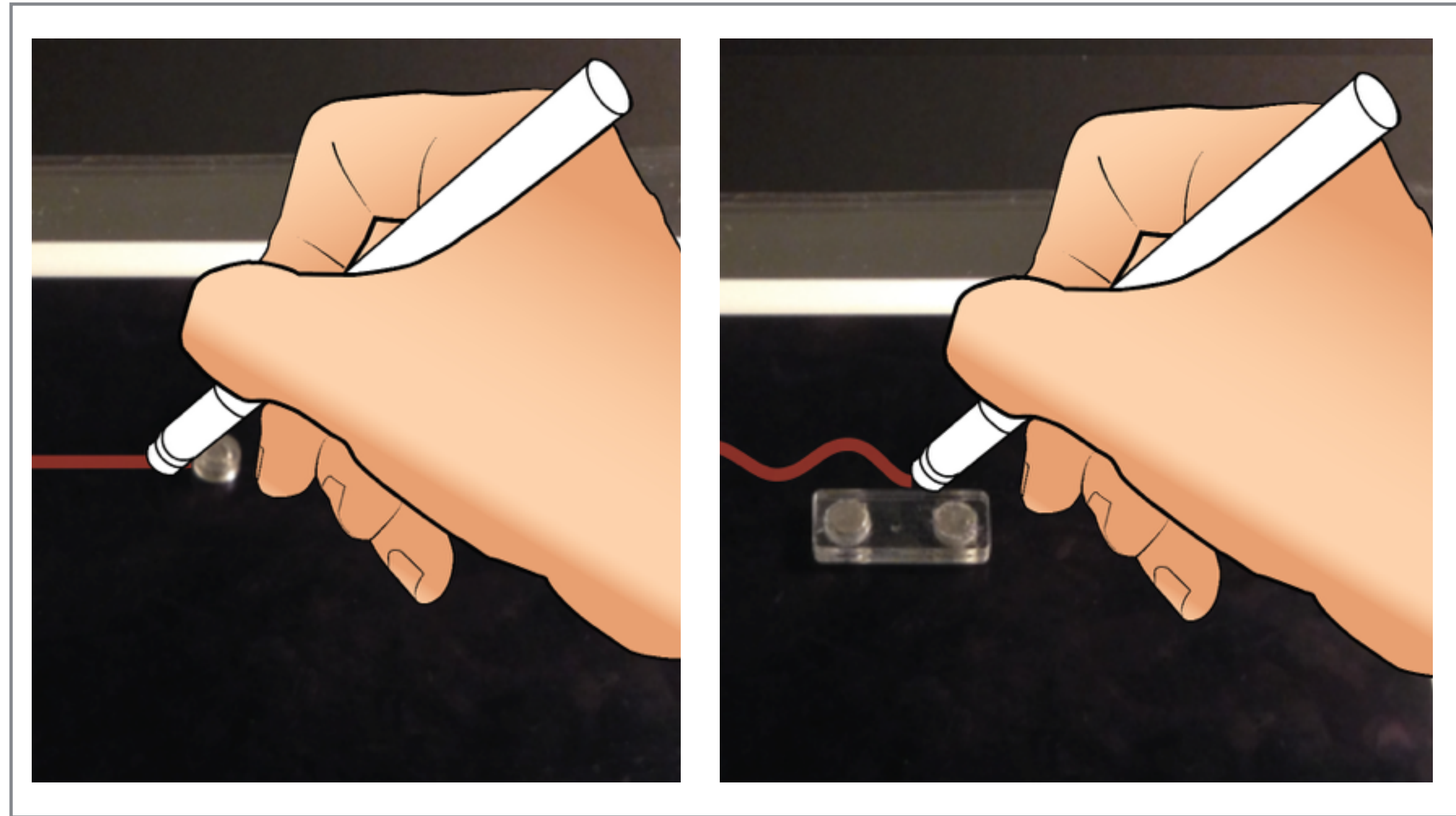

Soft constraint

Interaction Hard constraint

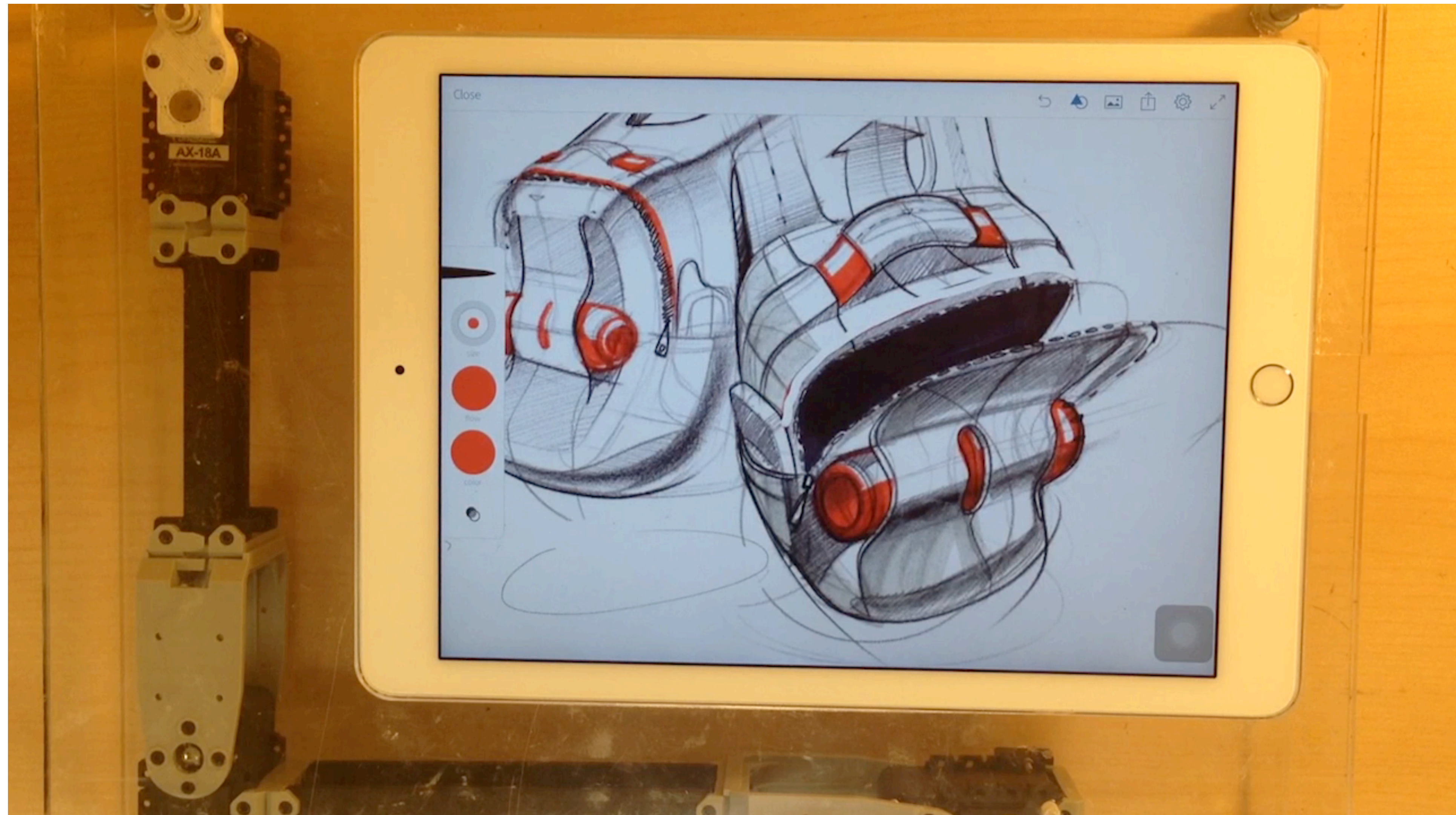

Interaction Soft constraint

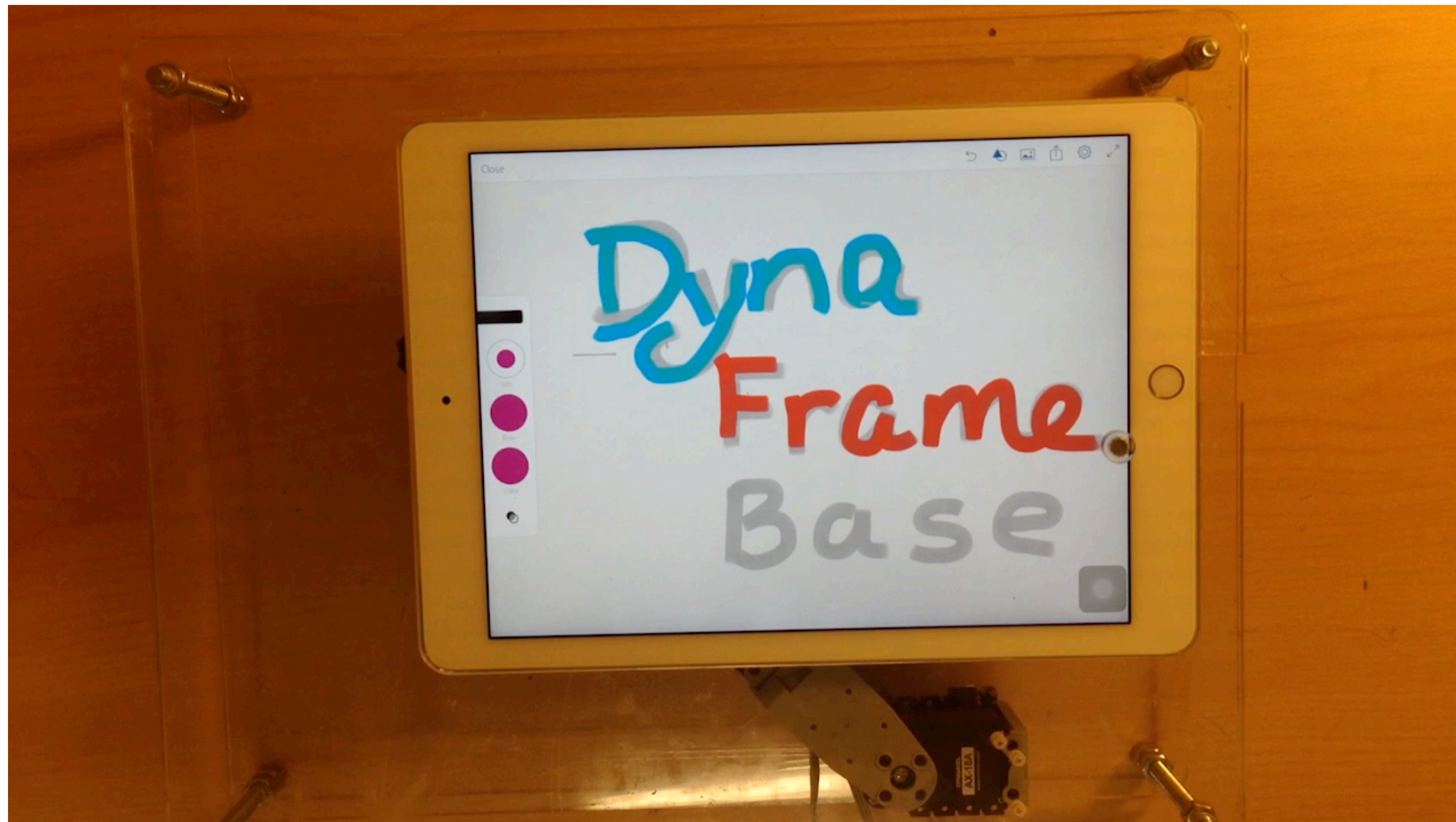

Toward orientation:

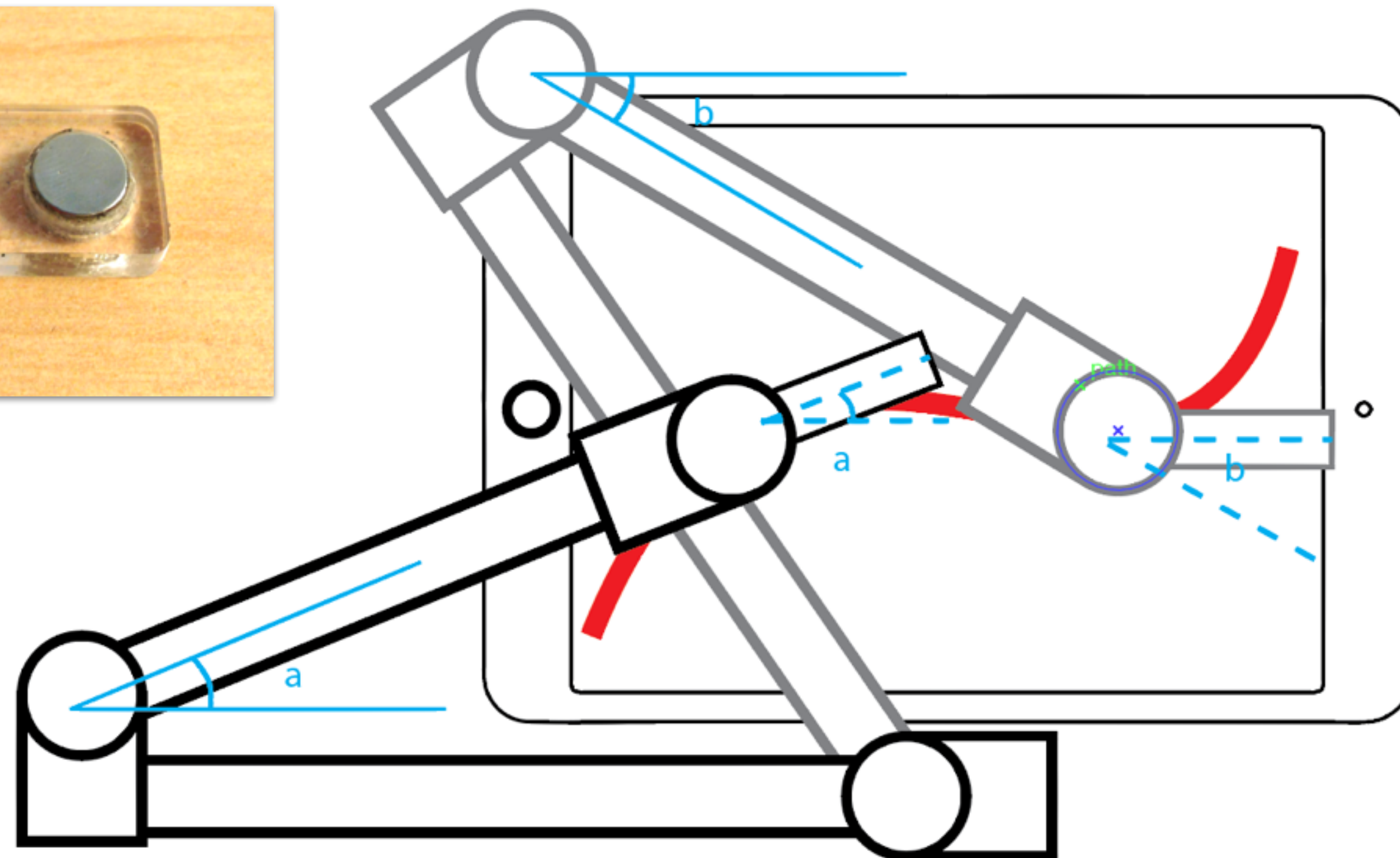
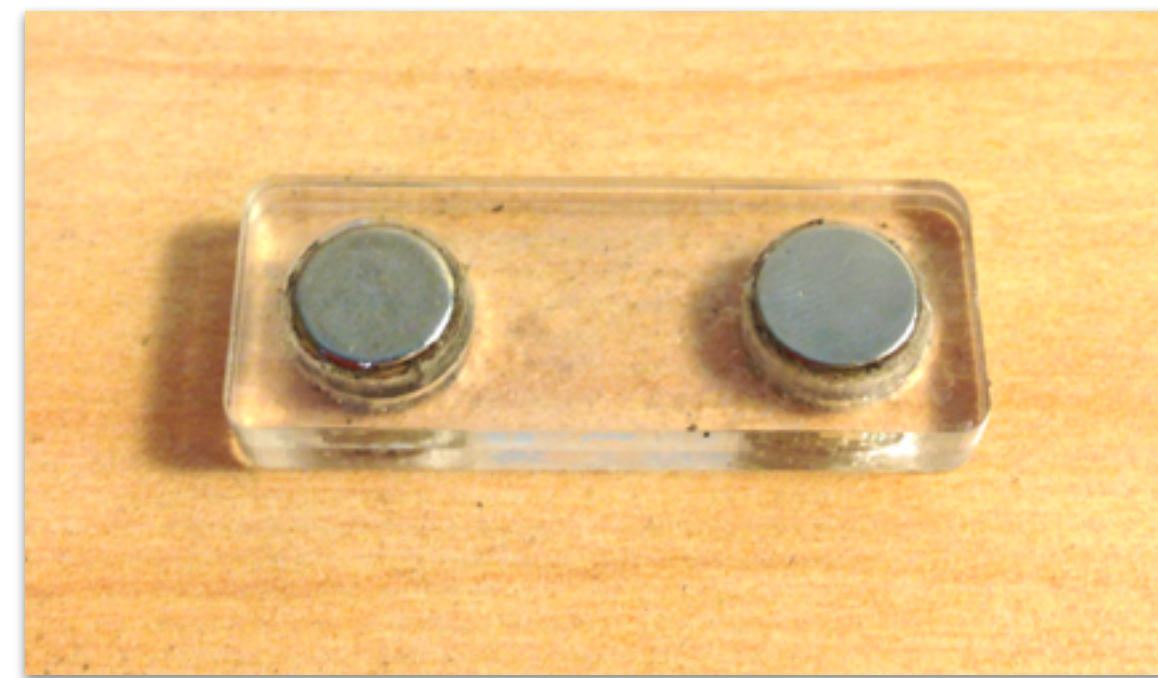

Toward orientation:

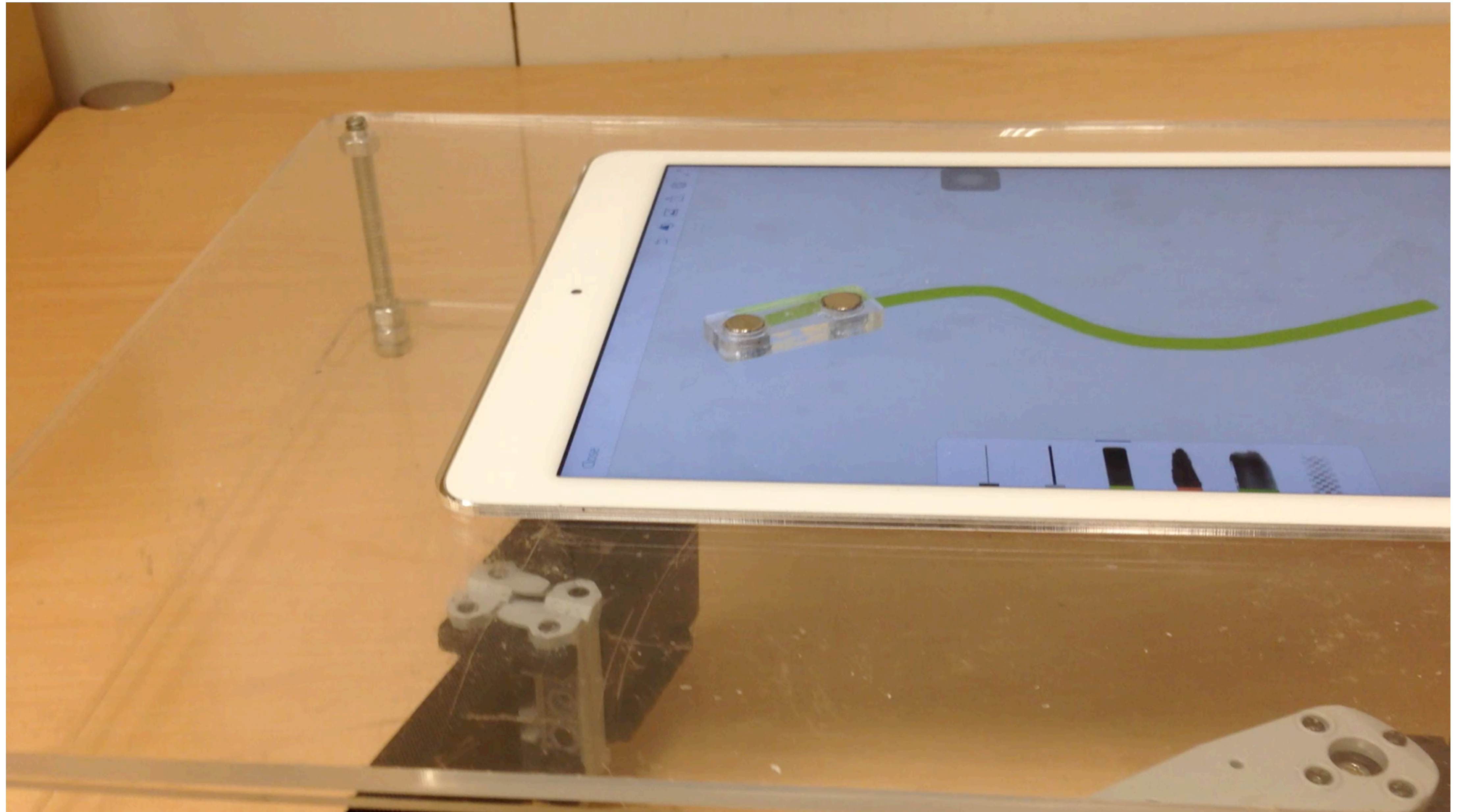

DynaBase

Back-of-display constraint

2D guidance
with orientation

Soft constraint

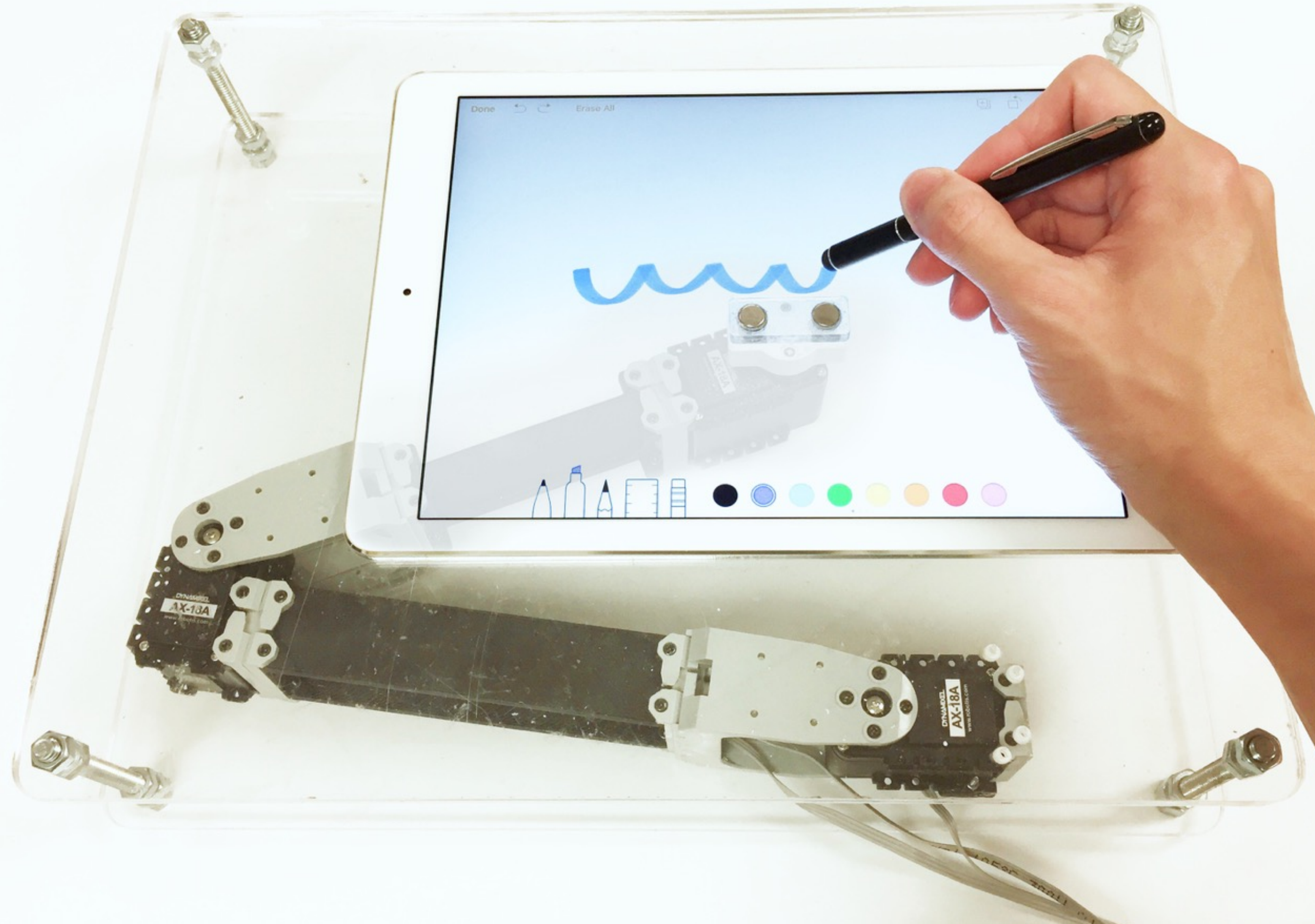

DynaFrame & DynaBase: User Interface

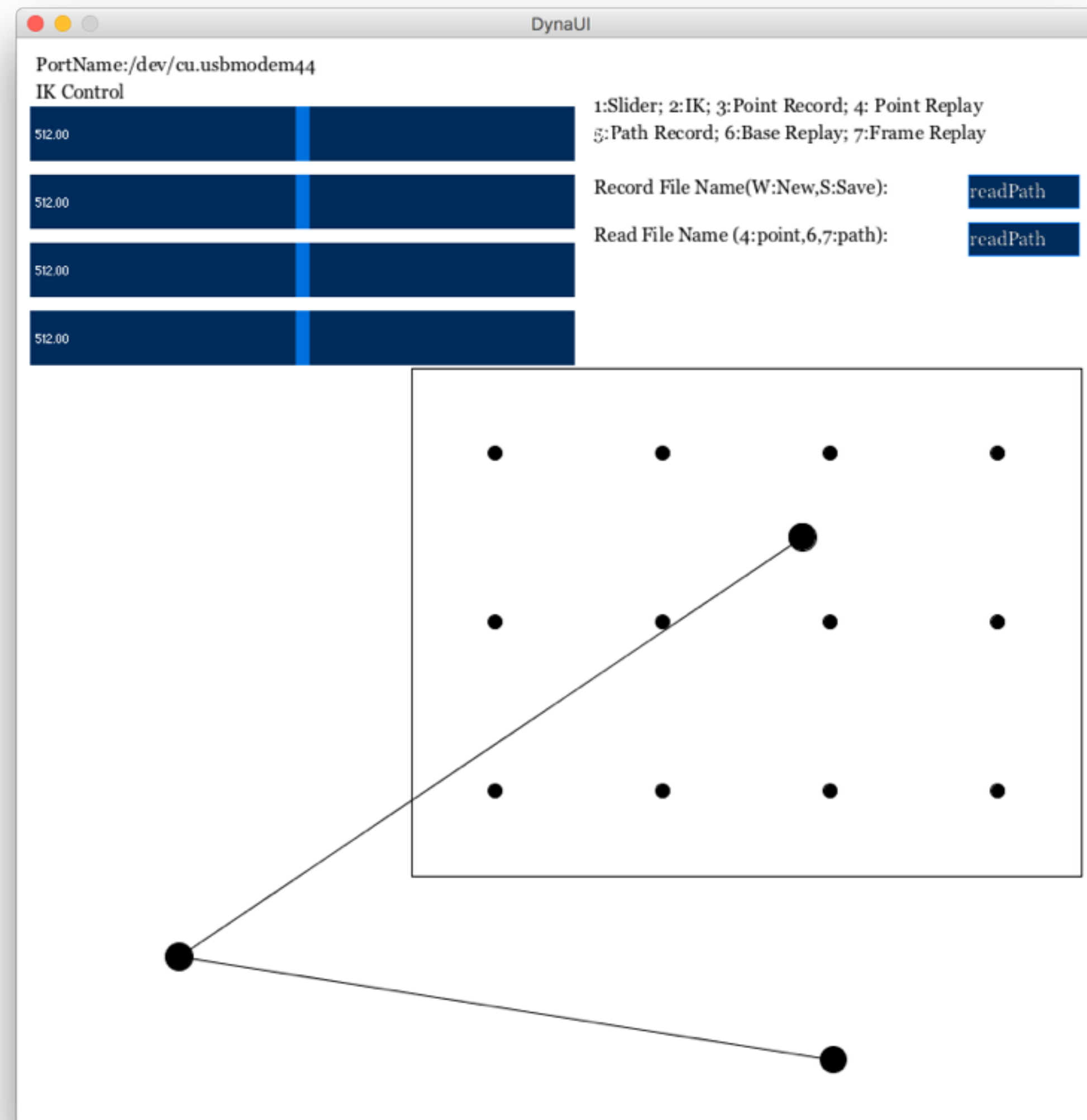

record path & speed
playback

robot arm simulation (IK)

Discussion

Form factor of DynaFrame



The robot arm provides **good portability** and **adaptability** but needs **control loop**

Actuators of DynaFrame



Smaller servos have **less occlusion**
but **small torque** and **low resolution**

Guidance of DynaBase

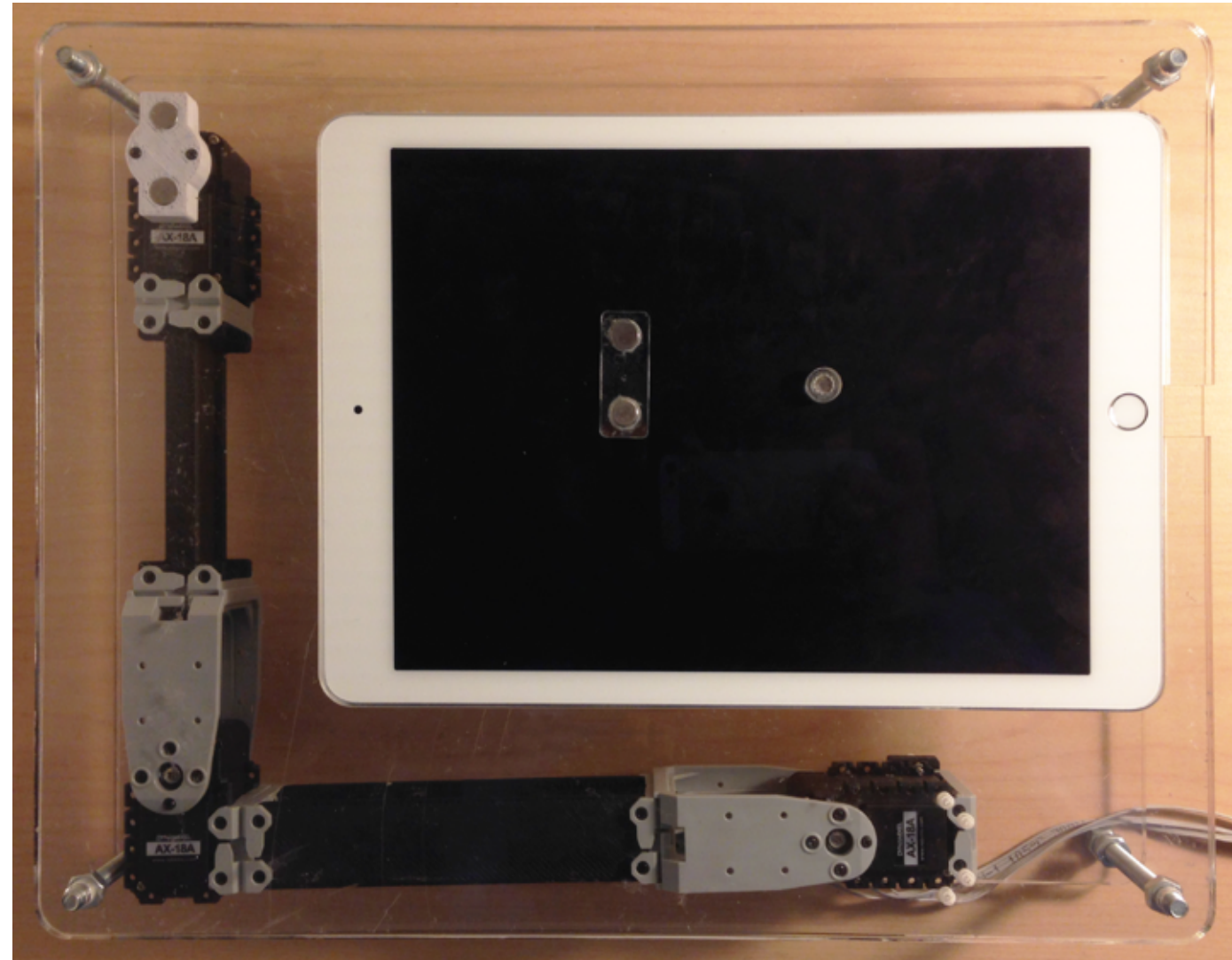

Dynamic attraction adapted to the content
using electromagnets

Conclusion

DynaFrame & DynaBase

hard and soft dynamic constraints
to facilitate **stylus** input with rich **haptic** feedback
on **portable displays**

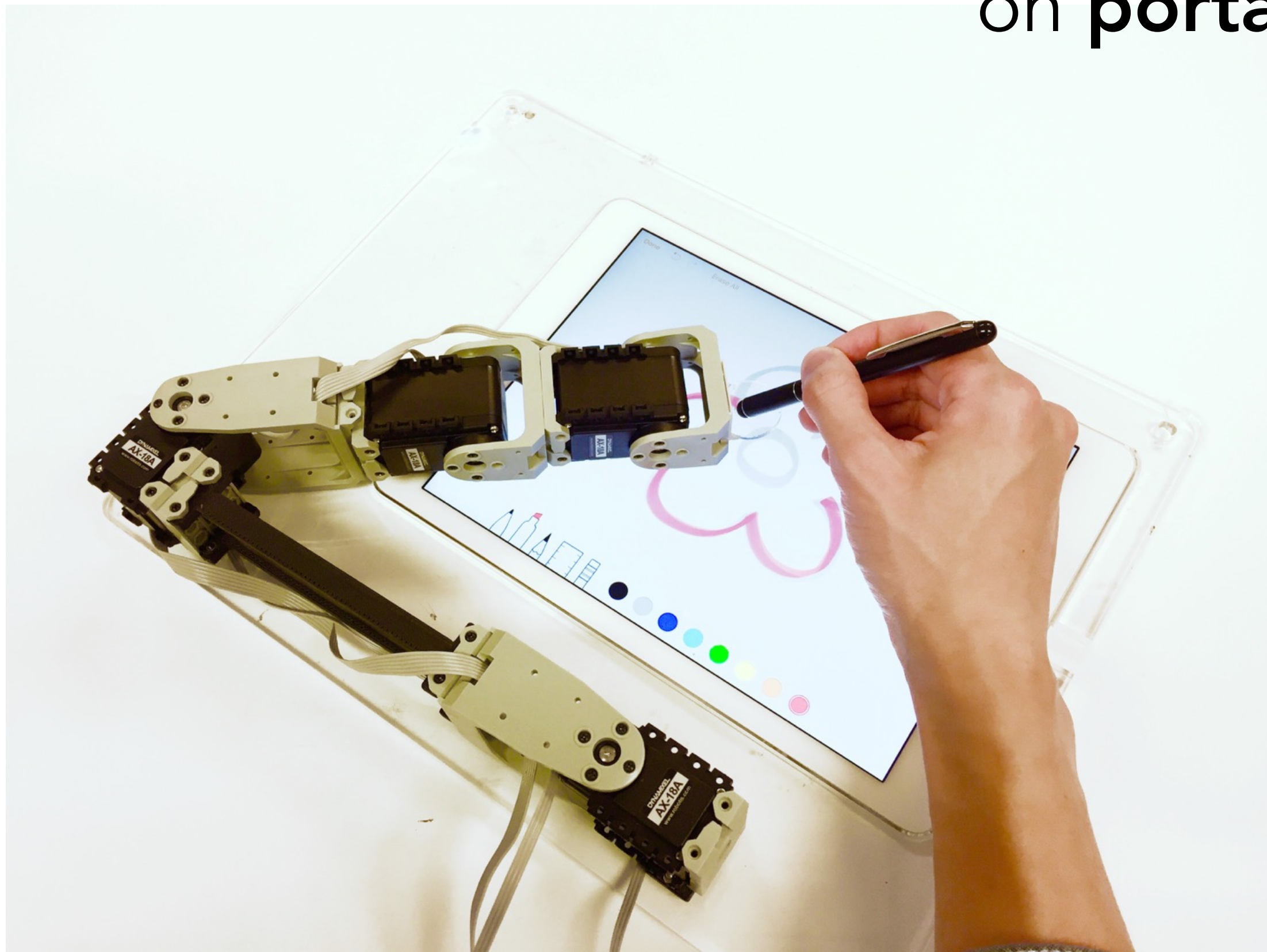



SIGGRAPH
ASIA 2016
MACAO

The End

Emerging Technologies

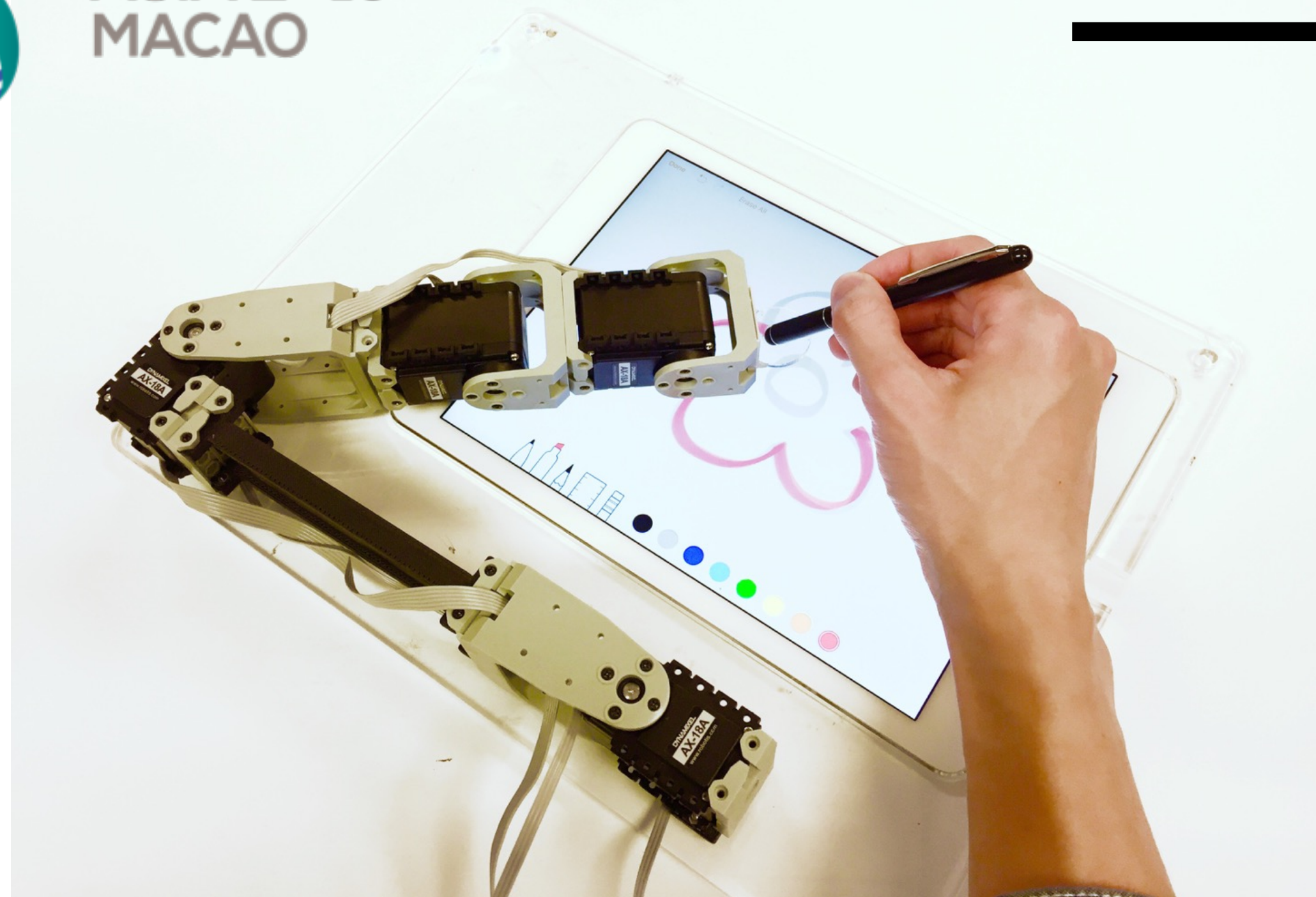

Stylus Assistant: Designing Dynamic Constraints for Facilitating Stylus Inputs on Portable Displays

Presenter: Shan-Yuan Teng
tanyuan@cmlab.csie.ntu.edu.tw

